



**STAR** ALUMİNYUM<sup>®</sup>  
PAZARLAMA

**SANAYİ VE TİCARET LTD. ŞTİ.**



**ISO 9001**  
REGISTERED FIRM

**ZEMİN PROFİLLERİ ve AKSESUARLARI**  
**FLOORING PROFILES & ACCESSORIES**

**2014**

**[www.utkan-star.com](http://www.utkan-star.com)**



# STAR GRUP



Star Alüminyum Paz.San. Ve Tic Ltd. Şti, 24 yıldır uzun soluklu, kaliteli hizmet anlayışıyla sektördeki diğer firmalar arasında ön plana çıkmayı başarmıştır.

Günden güne pazar ağını genişleten firmamız Çağlayan, Dudullu ve İkitelli - Başakşehir Plaza mağazalarında müşterilerin ihtiyaçlarına geniş ürün yelpazesıyla cevap vermektedir.

Star Alüminyum Çağlayan,Dudullu Şubelerine Başakşehir-İkitelli Plaza,binasını inşa ederek satış mağazasını büyüterek 9 katlı ofis ve showroomun yer aldığı 19800 m2 merkez binası haline gelmiştir. (Şubelerle beraber toplam 24050m2 kapalı alan) Firmada 4000 çeşit ürünün sergilendiği showroomda müşteriye seçenek konusunda büyük kolaylık sağlamaktadır. Alüminyum sektörü ile ilgili yurtiçi ve yurtdışında düzenlenen büyük fuarlarda yerini alan firmamız müşteri portföyünü 9000'e çıkarmayı başarsa da daha çok müşteriye ulaşmayı hedeflemektedir.

Kaliteye önem veren anlayışı ile ISO 9001:2008 Kalite Sistem Standardı'nı ve OHSAS 18001:2007 İş Sağlığı ve Güvenliğini rehber olarak kabul eden Star Alüminyum üretimden sevkiyata kadar tüm birimlerinde kalite kontrolünü büyük bir titizlikle denetleyerek 94 kişilik eğitilmiş ve tecrübeli ekibiyle, satış öncesi ve sonrası eksiksiz, kaliteli hizmet vermeyi şirket vizyonu olarak benimsemiştir.

Kendine özgü 3000 adet kalıpla yurtiçi ve yurtdışına profil satan firmamız, gelişen teknolojiyi yakından takip ederek gelen her türlü talebi müşteri memnuniyetini de göz önüne alarak karşılamaktadır. Müşteriye taahhüt edilen zamanda ve eksiksiz ürün teslimatı konusundaki duyarlılığıyla sektördeki farkını ortaya koymuştur.

Firmamız aynı zamanda mobilya kapak profilleri, bölücü paneller, kapı kasaları, bankolar, fuar standları, yönlendirici tabelalar ve merdiven korkuluğu gibi birçok imalatların dışında, müşteri istekleri doğrultusunda, proje bazında her türlü özel ürün taleplerini de eğitilmiş ve tecrübeli ekibiyle yerine getirebilmektedir.

Yurt içinde ve yurt dışında yapılandırılmış pazarlama ağını büyük bir titizlikle takip eden firmamız, 32 ülkeye ( Doğu Avrupa, Batı Avrupa, Kuzey Afrika, Orta Doğu, Orta Asya ülkeleri) yaptığı ihracat neticesinde de sektördeki pazar payını korumayı başarmıştır.

Alüminyum yüzey işleminde istenilen kaliteyi en üst seviyede tutmayı başaran firmamız, sektördeki üretici firmalarla yakın takipte olmak suretiyle kalite sınırını da zorlamaktadır.

Star Alüminyum, fiyat ve satış politikasında da gerektiği kadar esnek davranarak bu konudaki müşteri sıkıntılarını çözebilmeyi başarmıştır. ( Firmamız çok kısa bir zaman içinde E-Ticaret kanalıyla satış yapmayı hedeflemektedir.)

Saygıdeğer Müşterilerimiz,

Köklü bir ilişki, süreklilik getiren bir çözüm, kaliteli hizmet istiyorsanız mutlaka Star Alüminyum Ltd.Şti' ni ziyaret ediniz. Marketimizdeki zengin çeşitlerimizle sizlerin bulunduğu her noktada sınırsız hizmet anlayışımızla buradayız.

Sayılarımızla

**Star Alüminyum Ltd.Şti' nin Satış ve Pazarlamasını yaptığı, imalat sektörüne ait PROFİLLER VE AKSESUARLAR**

1. Soğutucu ve market tipi buzdolabı imalatçılarına yönelik profil ve aksesuarlar
2. Mobilya ve mutfak dolapları imalatçılarına yönelik profiller
3. Dik dolap askılı sürgü imalatçılarına yönelik profiller
4. Soğuk oda panel kalıplan
5. Klima santral kasaları profilleri
6. Mobilya -Sunta derz kapama profilleri
7. Mobilya köşe askılı profilleri ve aksesuarları
8. Ray dolabı imalatçılarına yönelik profiller
9. Kış bahçesi imalatçılarına yönelik üst kaplama profilleri
10. Laminant kapı kasaları
11. Ahşap pencere damlalık profilleri
12. Kompozit panel ek profilleri ve kablo kanalları
13. Alüminyum süpürgelik ve basamak profilleri
14. Halı ve lamine uygulayan firmalara yönelik profiller
15. PVC süpürgelikler
16. Fayans çitane,dekorasyon profilleri ve aksesuarları
17. Diletasyon profilleri
18. Fuar standı ve banko uygulayan firmalara yönelik profiller
19. Sigma ve konviyör profilleri
20. Özel kutular ve borular
21. Granit cephe ve güneş kırıcı profilleri
22. Merdiven ve küpeşte profilleri ve aksesuarları
23. Sigma aksesuarları
24. Perçinler ve vidalar

About us

Star Aluminium Paz. San. And Trading Co., Ltd. Co., 24 years is a long -term , high-quality service with an understanding of other companies in the industry has managed to come to the fore .

Day after day our company expand its network Çağlayan,Başakşehir - İkitelli Plaza and in Dudullu wide range of needs of the customers in the stores the answer.

Star Aluminium Çağlayan,Dudullu Başakşehir-İkitelli Plaza, building expanding by building stores in 9-storey office and showroom located in the 19,800 m2 building has become center. (Branch together with a total covered area of 24,050m2 ) 4000 kinds of products are on display in the company showroom about my options provide great convenience to the customer. Aluminium industry-related domestic and international trade fairs held in place in a great area to remove the head of our company is customer portfolio in 9000 and aims to reach more customers.

Under the guidance of the ISO 9001:2008 quality system standards, and OHSAS 18001:2007 Occupational Health and Safety Star Aluminium checks quality control in all items from production to transportation and aims at customer satisfaction and continuity with its experienced team. Our firm sells domestic and foreign profile with its 1300 unique molds, and it has been able to catch up with developments by following technology closely and it has proven itself to be a sensitive firm about timely delivery of products with customer satisfaction.

Besides its many products, such as kitchen door frames, dividing panels, door cases, banks, fair stalls, direction signs and stair rails, our firm can provide special products upon our customers' request on the basis of project with its experienced team of 70 employees.

Following domestic and foreign marketing network closely, our firm has been able to secure its market share, thanks to the exportation from its head sales Office at Istanbul-Caglayan to 30 different countries. We do business in Eastern & Western Europe, North Africa, Middle East & Middle Asia). Our firm, succeeding in keeping the quality at aluminum surface process at the highest level, strains quality borders by closely following manufacturer firms operating at this field.

Star Aluminium has always been flexible about price and sales policy and it has been able to solve its customers' problems regarding this issue. Dear Customers; We do not recommend thinking with biases before contacting our firm and comparing with other firms. If you desire a deep-seated relation, Solutions bringing continuity, and a high quality service, visit STAR ALUMİNYUM LTD. STI. We are waiting for you with our rich varieties and boundless Services at any point.

With respect,

**Profiles and accessories of Manufacturing Sectors, of which Star Aluminium firm performs sales and marketing**

1. Profiles and accessories for cooler and market type refrigerator manufacturers
2. Profiles for furniture and kitchen cupboard manufacturers
3. Profiles for straight cupboard hanged bolt manufacturers
4. Cool room panel doors.
5. Air conditioner Central cases profiles.
6. Furniture-fiberboard seam covering profiles
7. Furniture side, hanger profiles and accessories
8. Profiles for rail cupboard manufacturers
9. Top covering profiles for winter garden manufacturers
10. Laminated door cases
11. Wooden window dropper profiles
12. Composite panel addition profiles and cable channels
13. Aluminum baseboard and step profiles
14. Profiles for Carpet and Laminated parquet firms
15. PVC baseboards
16. Faience laths, decoration profiles and accessories
17. Dilatation profiles
18. Profiles for Fair stall and bank firms
19. Sigma and conveyor profiles
20. Special boxes and pipes
21. Granite front and sunray breaking profiles
22. Stair rail profiles and accessories
23. Sigma accessories
24. Rivets and screws

## ALÜMİNYUM SÜPÜRGELİK PROFİLLERİ ALUMINIUM BASEBOARD PROFILES

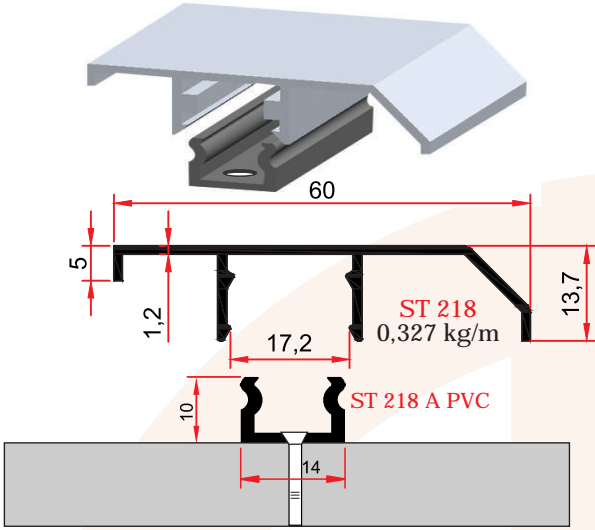

**218 SÜPÜRGELİK İÇ KÖŞE -DİŞ KÖŞE TAPA**  
ST 218 BASEBOARD INNER-OUTER CORNERS & PLUG

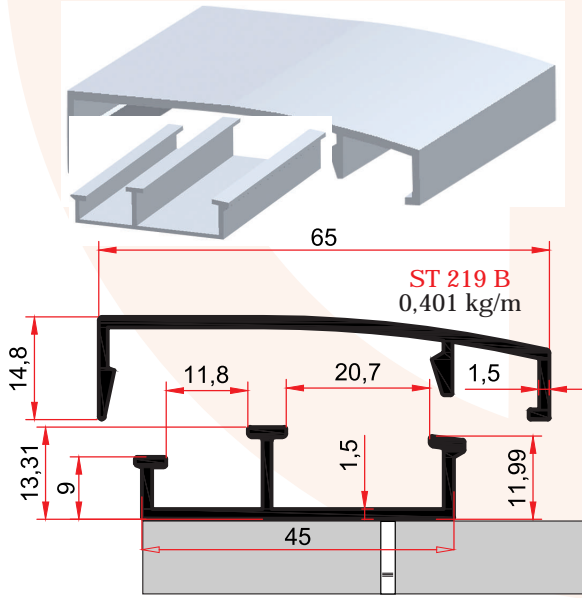

**ST 219 C**  
0,343 kg/m



**ST 226**  
0,586 kg/m

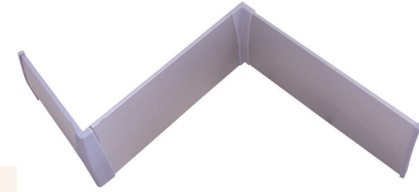
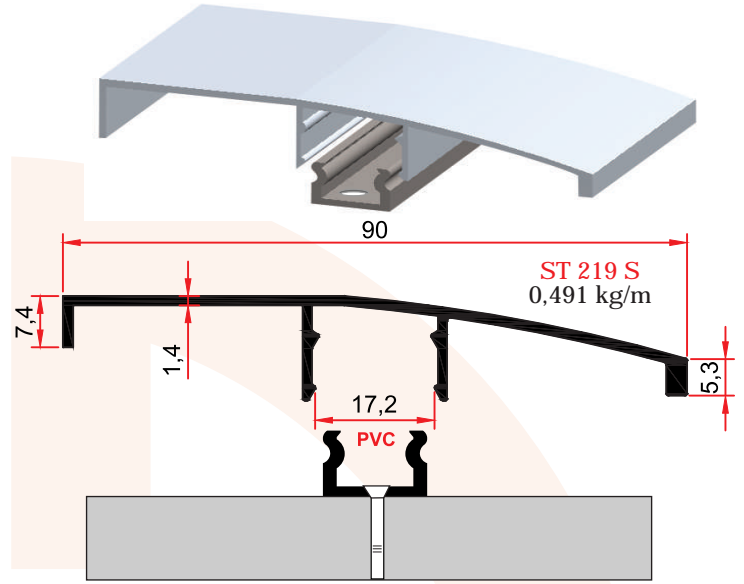
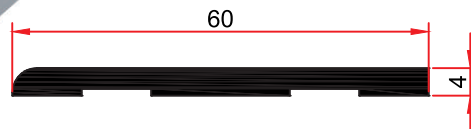

**219 S SÜPÜRGELİK İÇ KÖŞE DİŞ KÖŞE TAPA**  
ST 219 S BASEBOARD INNER-OUTER CORNERS & PLUG

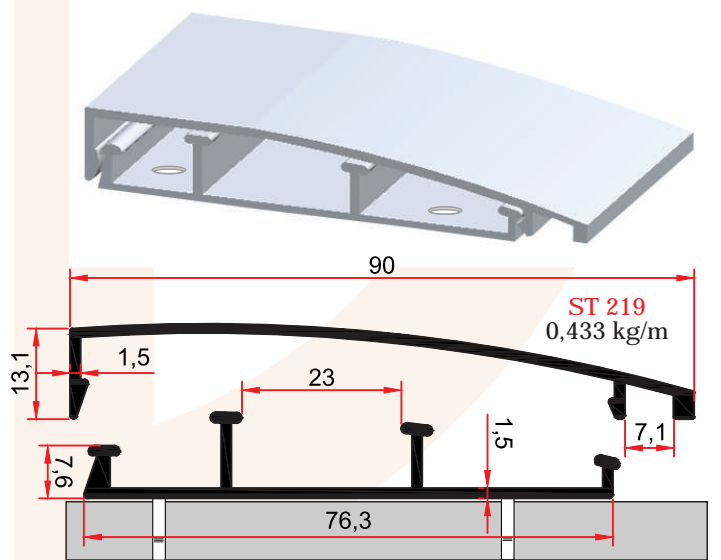

**ST 219 Alt**  
0,487 kg/m

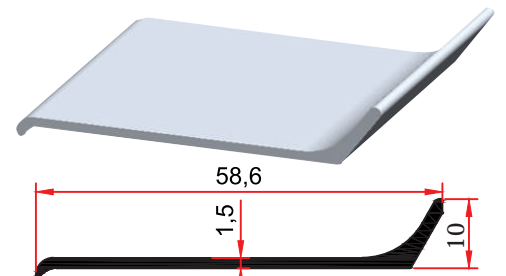

**ST 219 L**  
0,280 kg/m

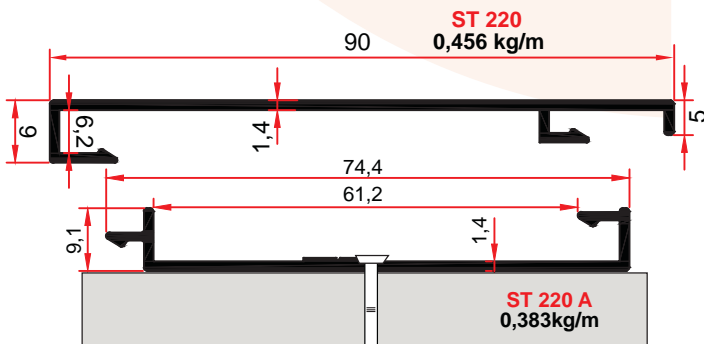
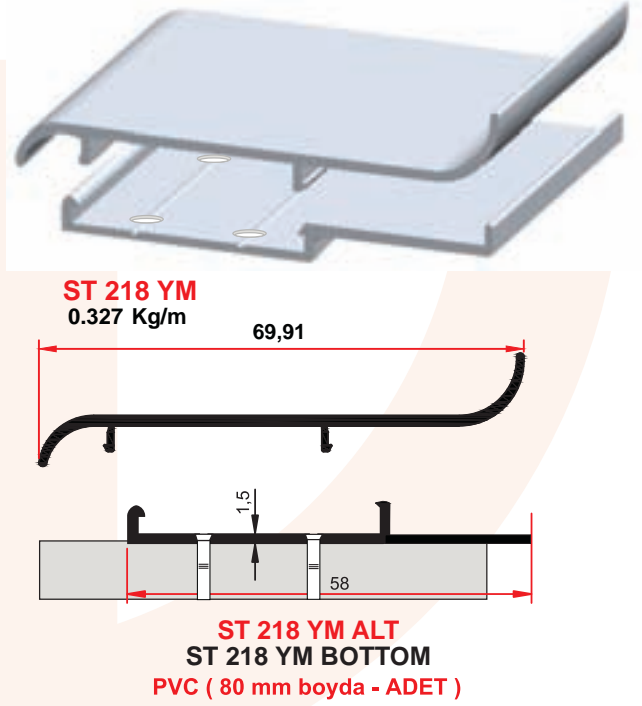
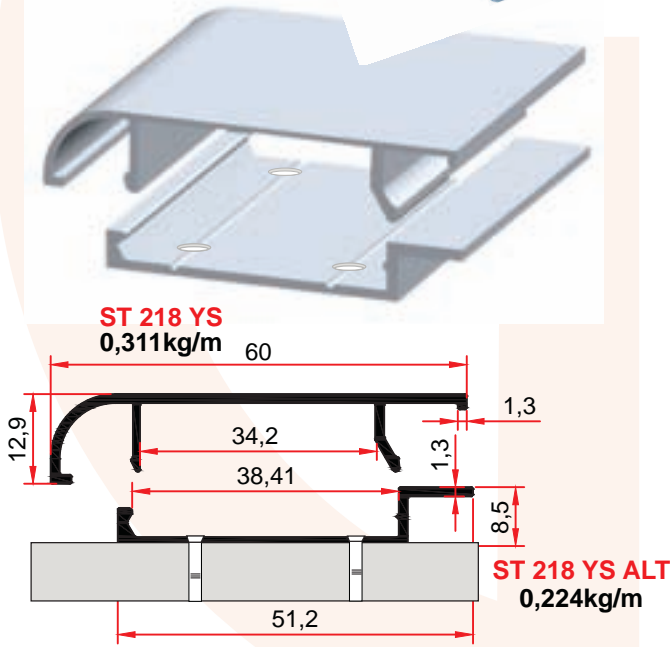
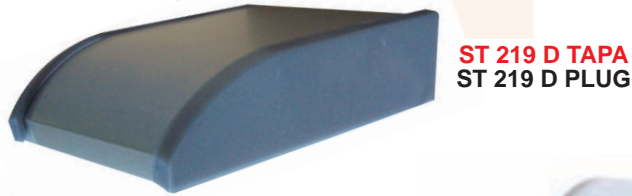
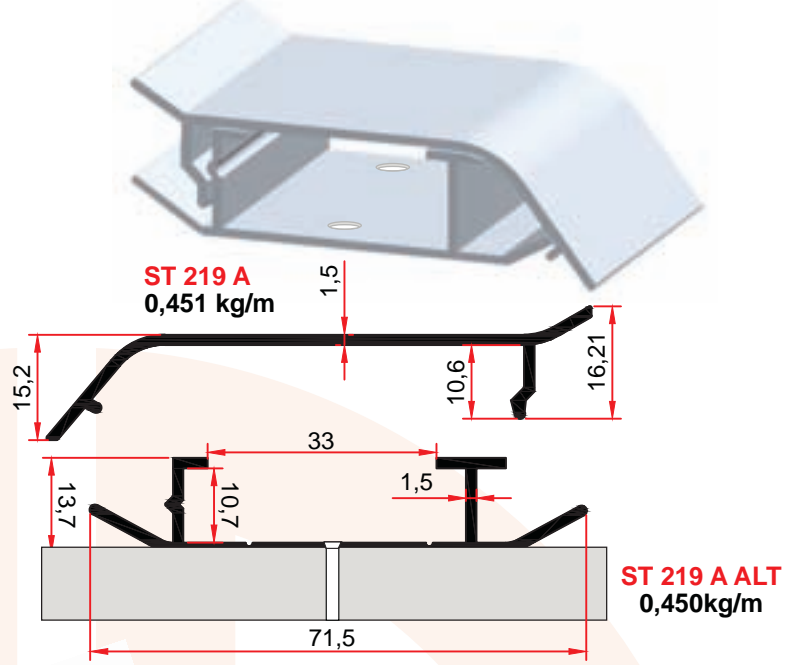
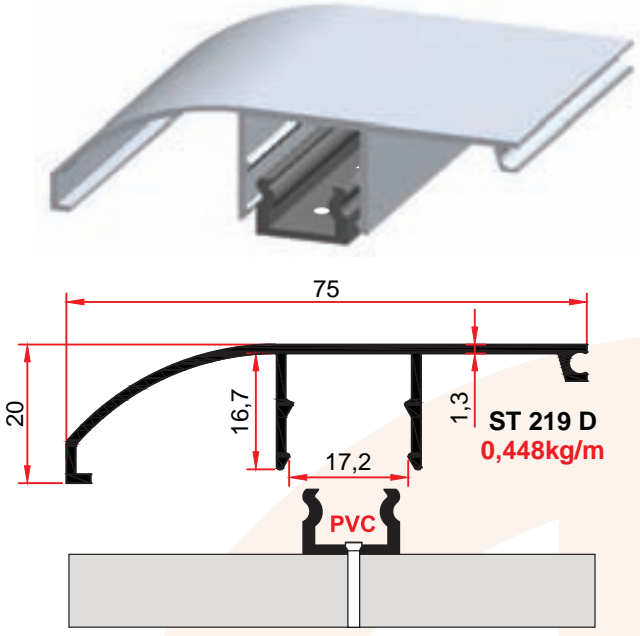

## ALÜMİNYUM SÜPÜRGELİK PROFİLLERİ ALUMINIUM BASEBOARD PROFILES

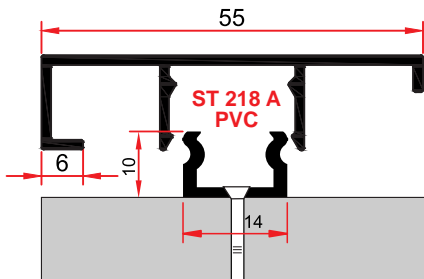
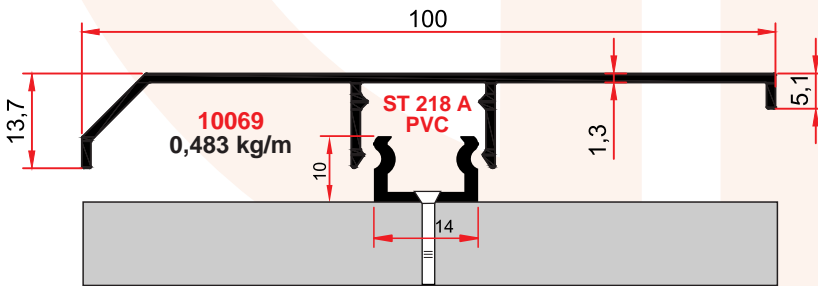
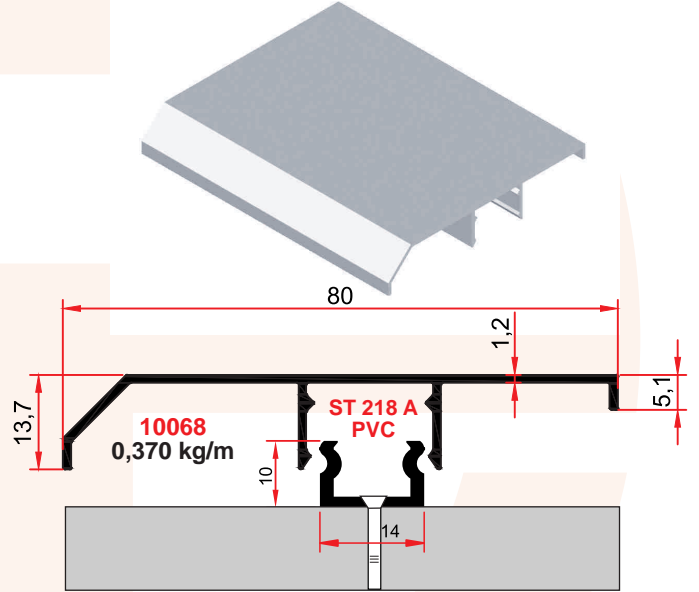
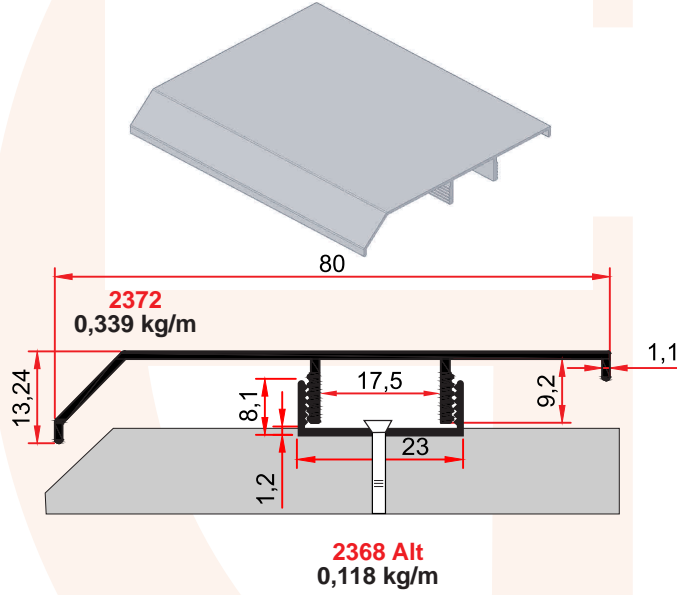
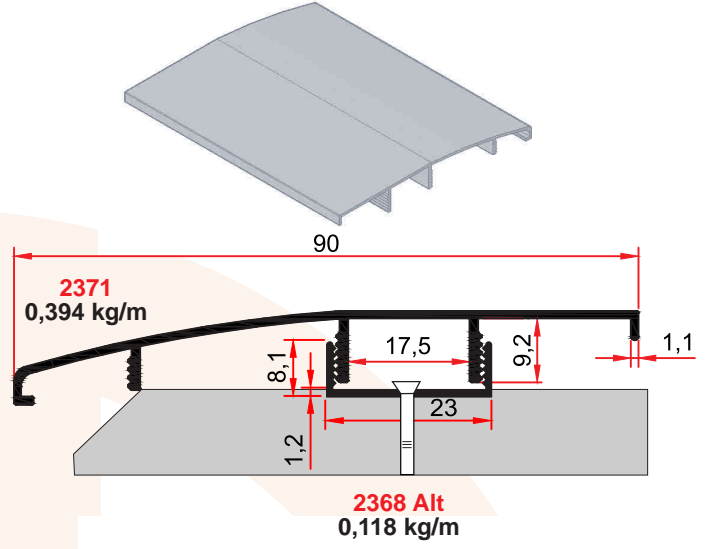
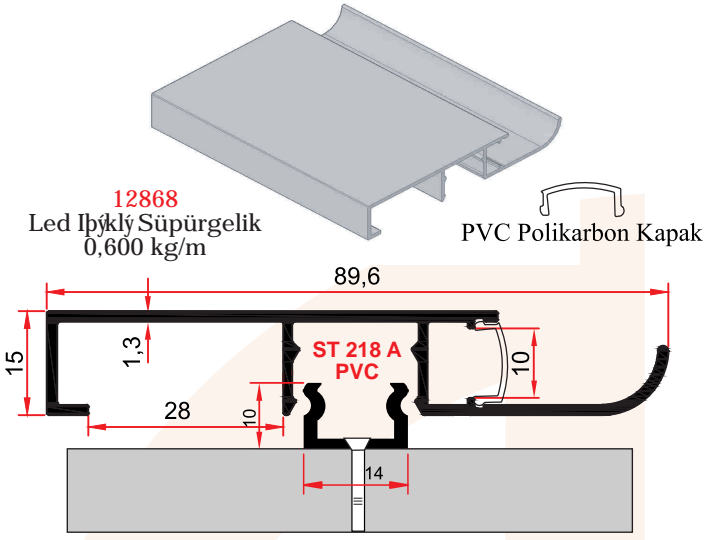

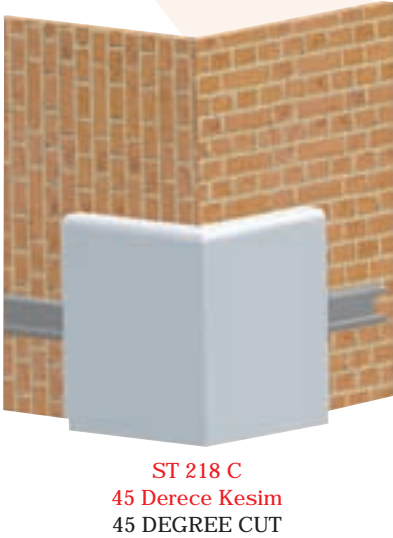
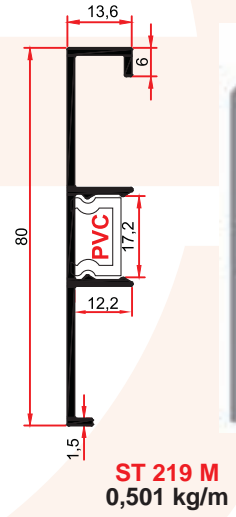
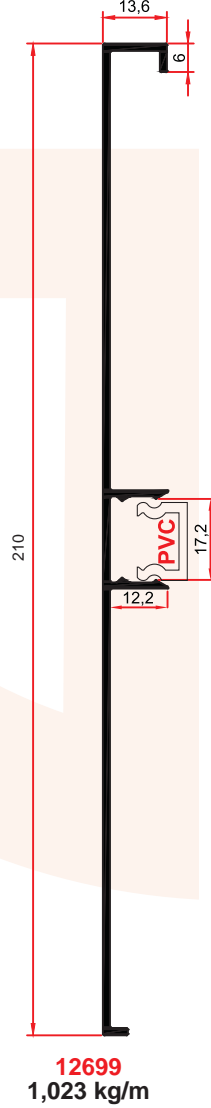
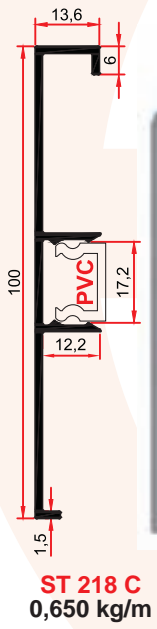
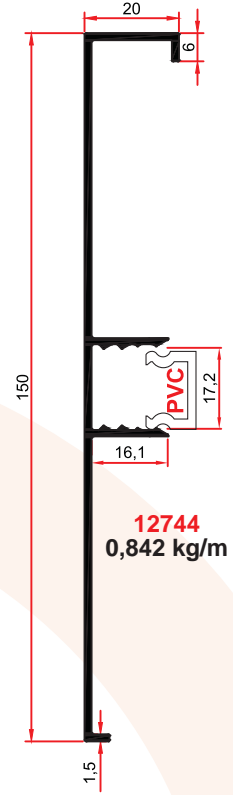
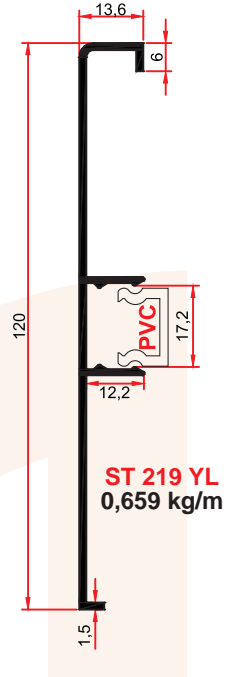
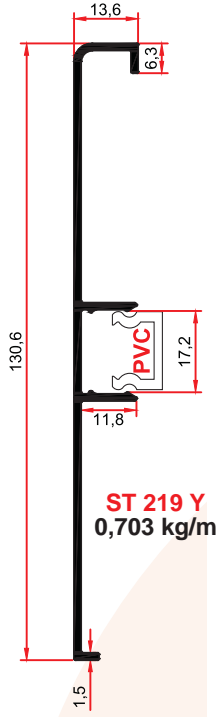

## ALÜMİNYUM BASAMAK PROFİLLERİ ALUMINIUM STEP PROFILES

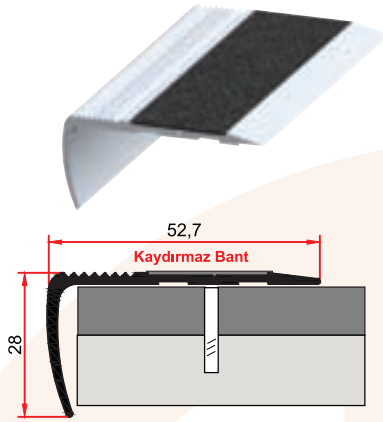

**ST 207**  
0,351 kg/m

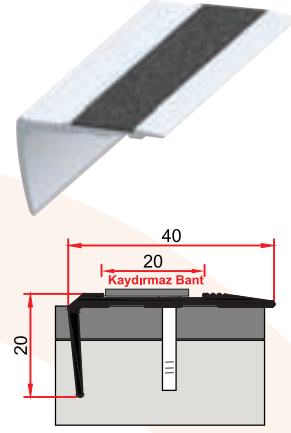

**ST 207 A**  
0,246 kg/m

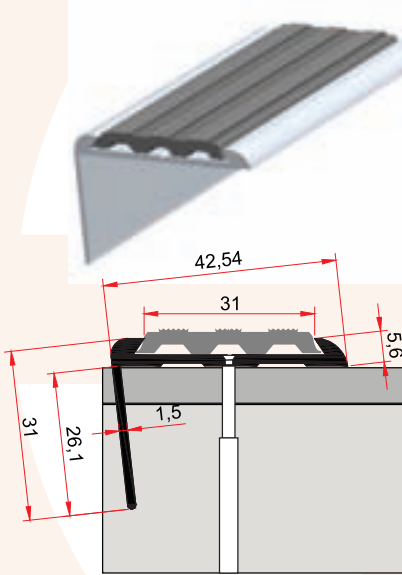

**ST 208**  
0,373 kg/m

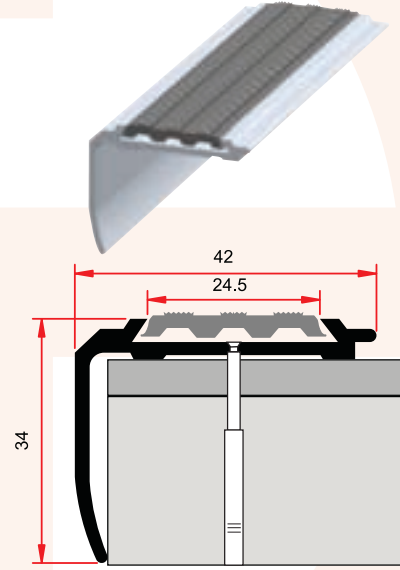

**ST 208 A**  
0,246 kg/m

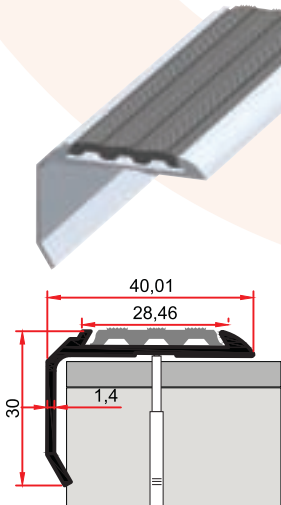

**ST 208 B**  
0,305 kg/m

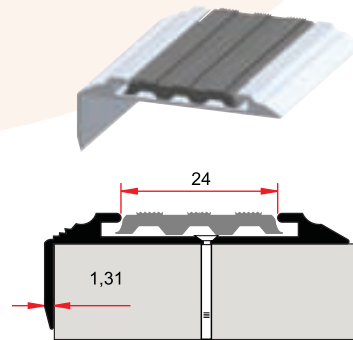

**ST 208 C**  
0,256 kg/m

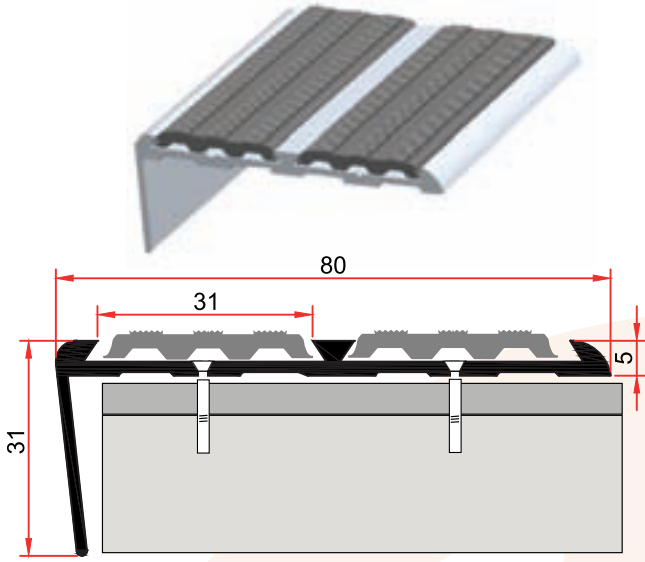

**ST 209**  
0,581 kg/m

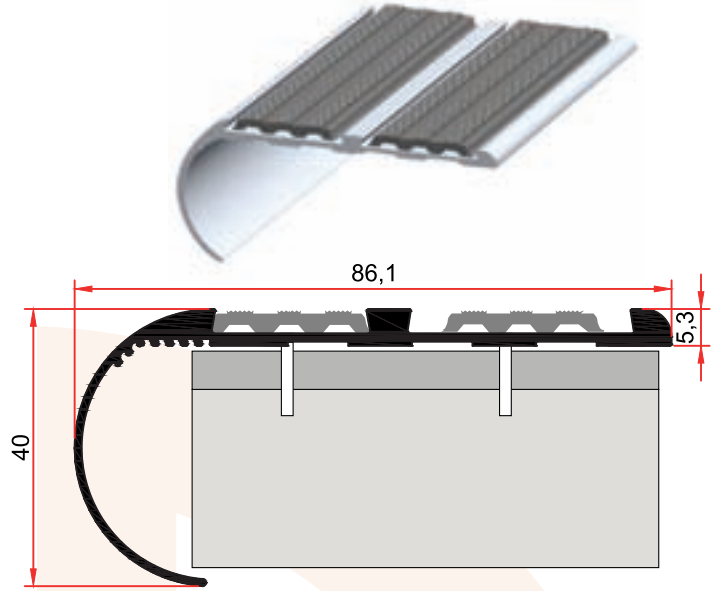

**ST 211**  
0,709 kg/m

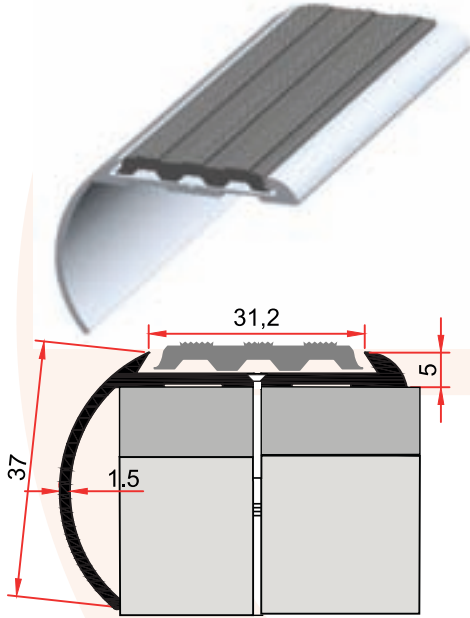

**ST 210**  
0,389 kg/m



**Basamak Fitili**  
Step Wick

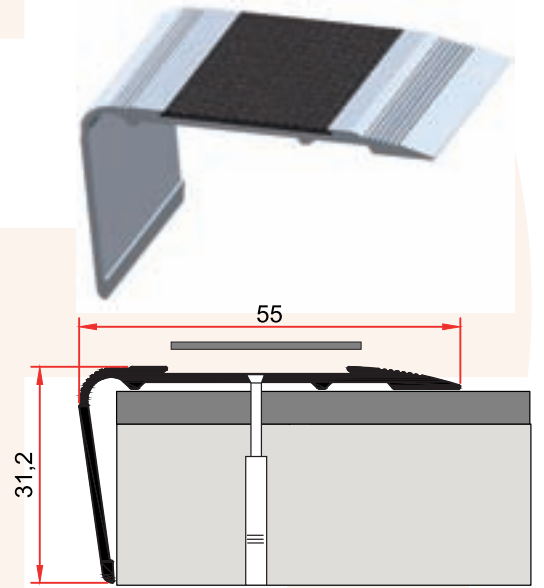

**ST 210 A**  
0,332 kg/m

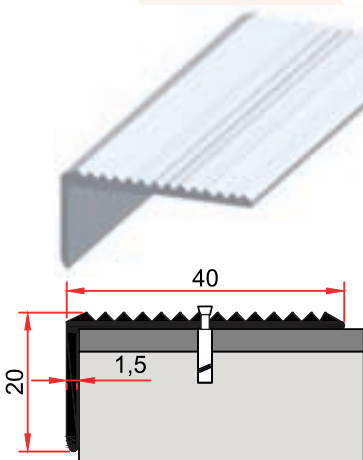

**ST 233**  
0,251 kg/m

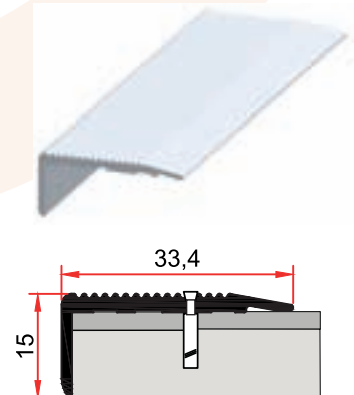

**ST 233 A**  
0,230 kg/m

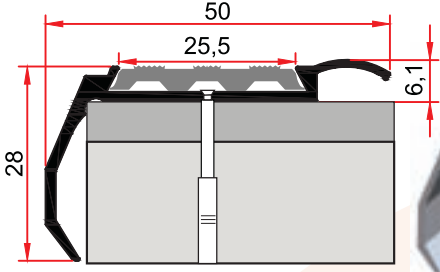

**MP 34**  
0,320 kg/m

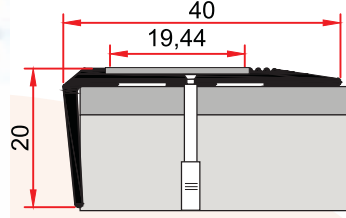
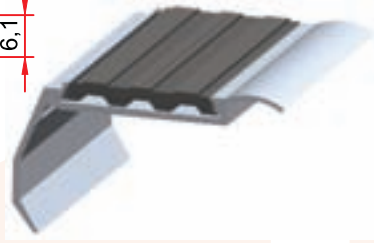

**MP 35**  
0,246 kg/m

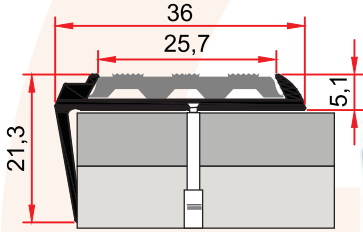
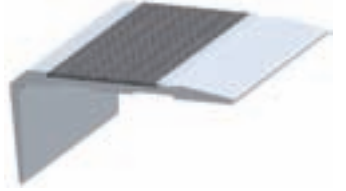

**MP 36**  
0,246 kg/m

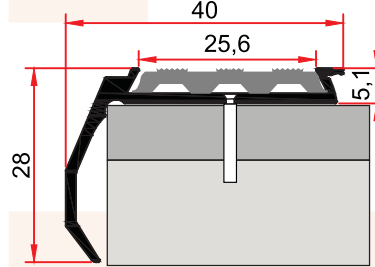
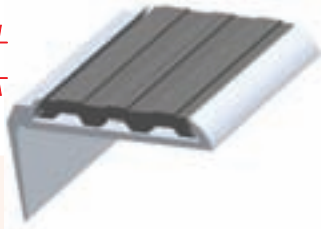

**MP 37**  
0,286 kg/m

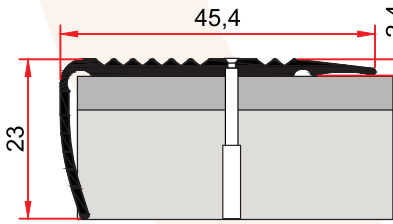

**MP 38**  
0,284 kg/m

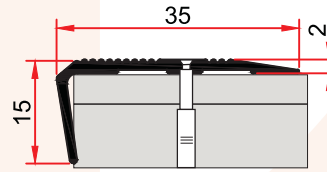

**MP 39**  
0,180 kg/m

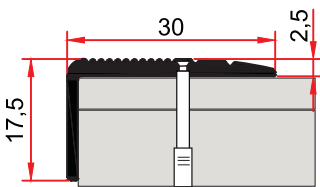

**MP 40**  
0,232 kg/m

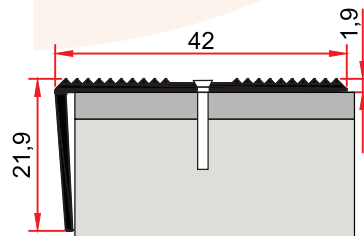
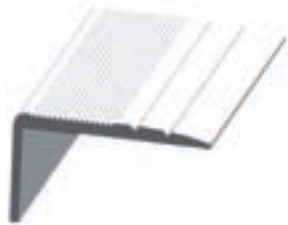

**ST 244**  
0,231 kg/m

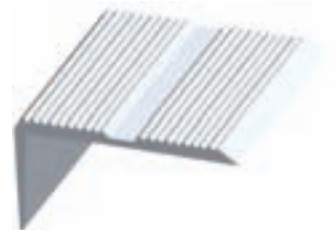

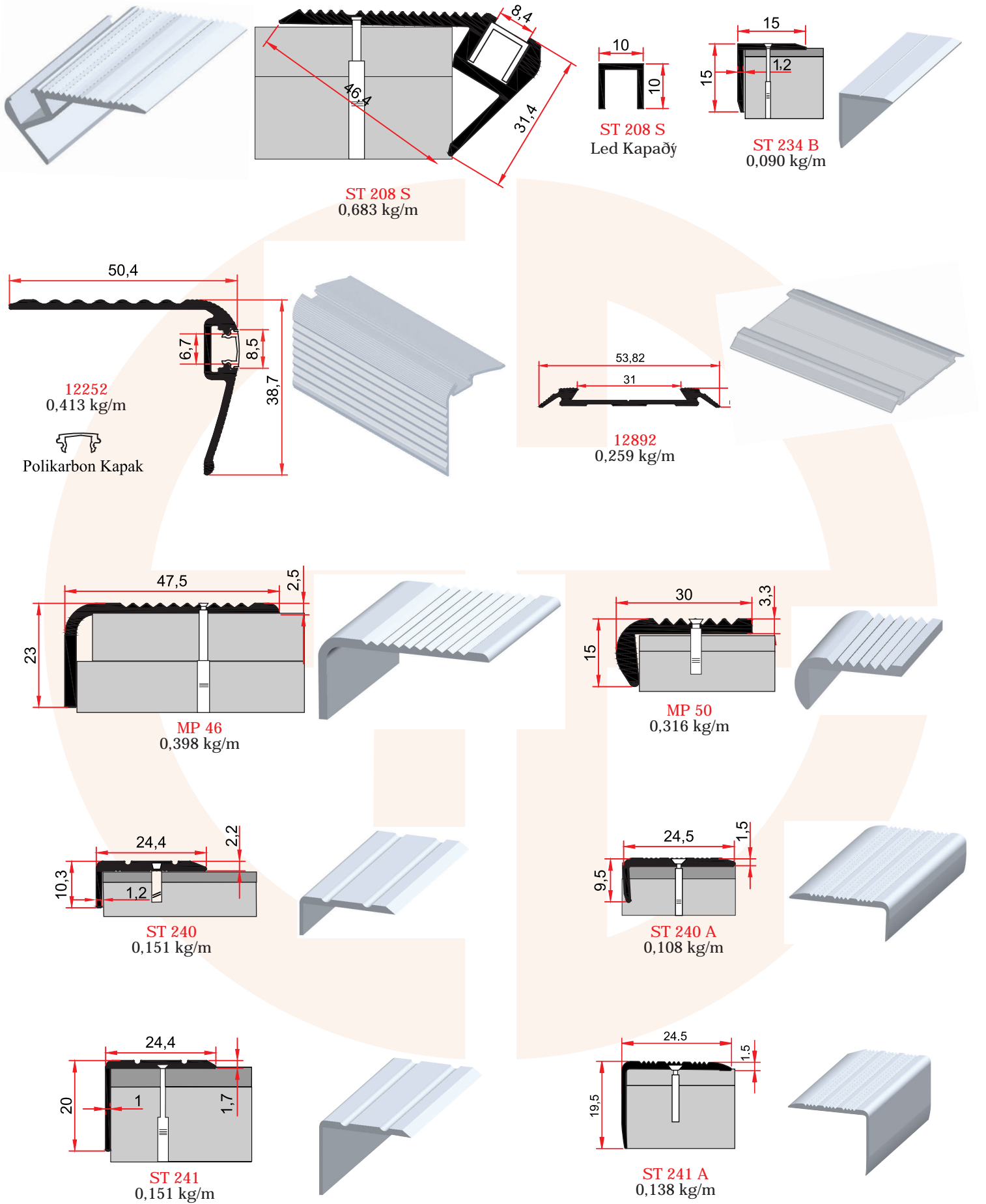

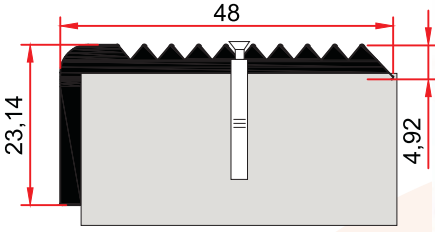

**MP 47**  
0,660 kg/m

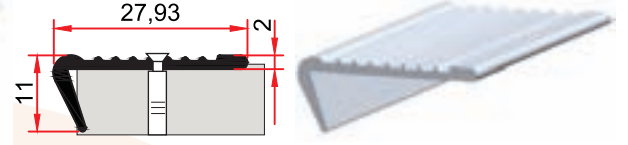

**MP 51**  
0,154 kg/m

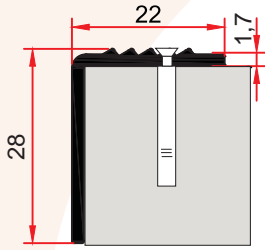

**MP 48**  
0,228 kg/m

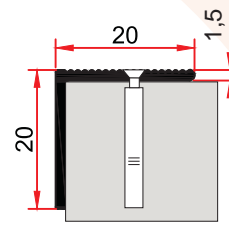
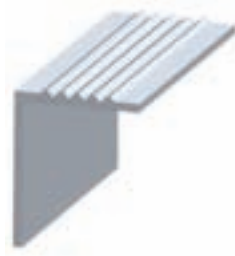

**MP 49**  
0,146 kg/m

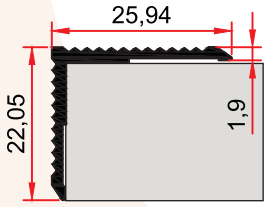

**ST 241 B**  
0,180 kg/m

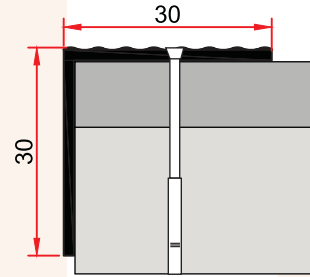
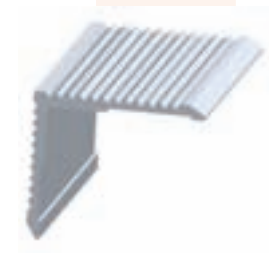

**MP 21**  
0,252 kg/m

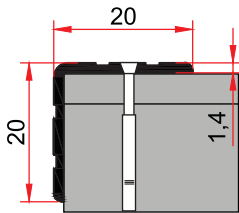

**MP 19**  
0,140 kg/m

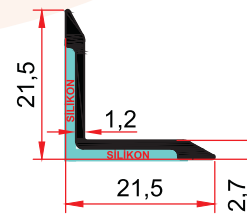
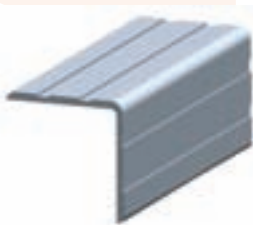

**MP 15**  
0,146 kg/m

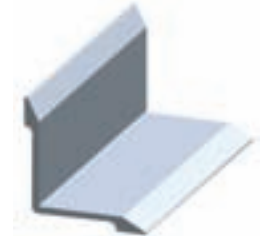

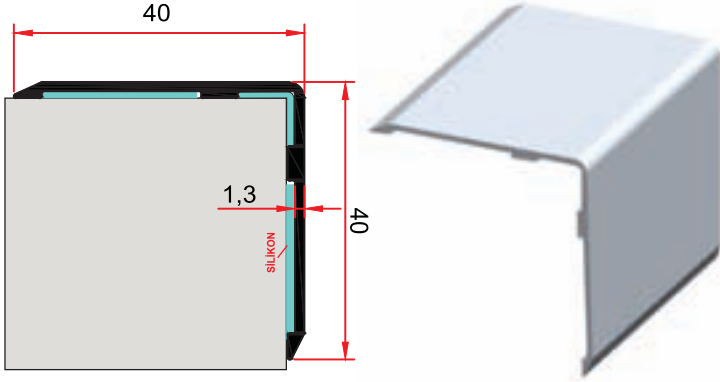

**SM 1064 A**  
0,302 kg/m

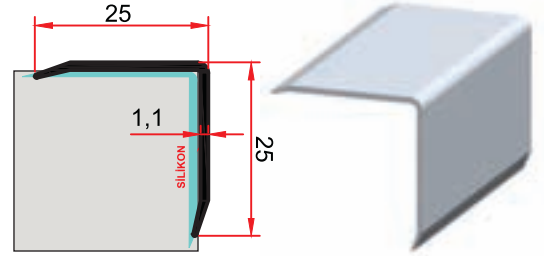

**SM 1064 C**  
0,138 kg/m

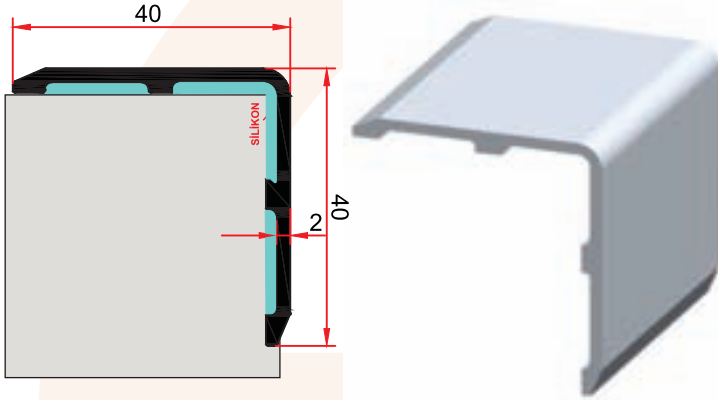

**MP 41**  
0,467 kg/m

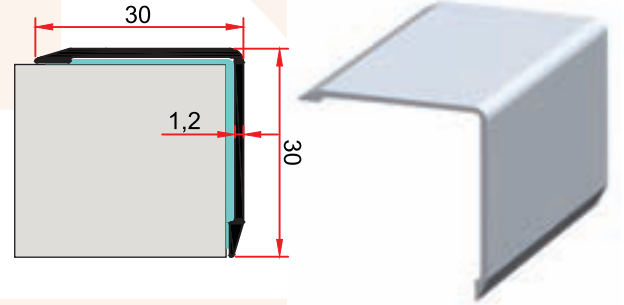

**MP 43**  
0,190 kg/m

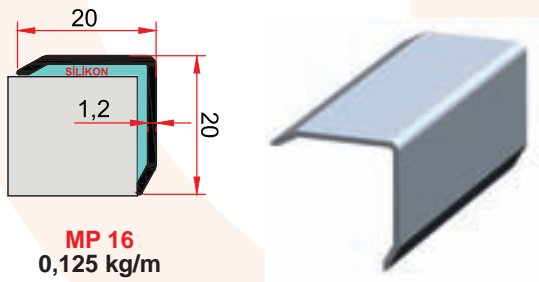

**MP 16**  
0,125 kg/m

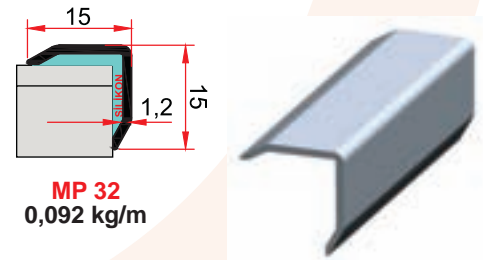

**MP 32**  
0,092 kg/m

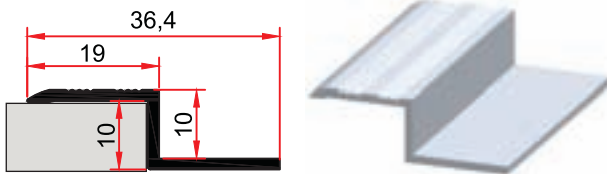

**SM 1064 B**  
0,193 kg/m

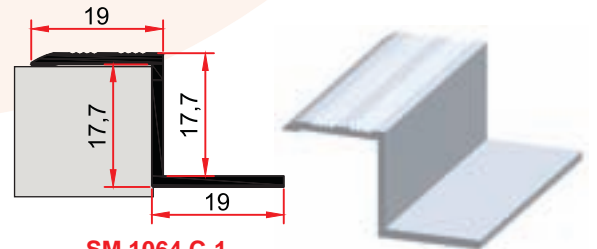

**SM 1064 C-1**  
0,227 kg/m

## DİLETASYON PROFİLLERİ DILATATION PROFILES

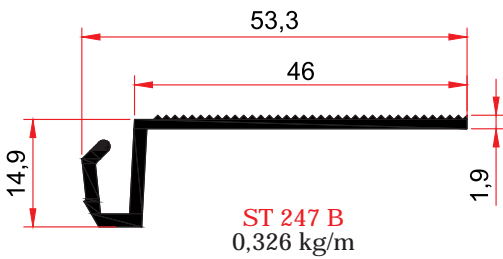
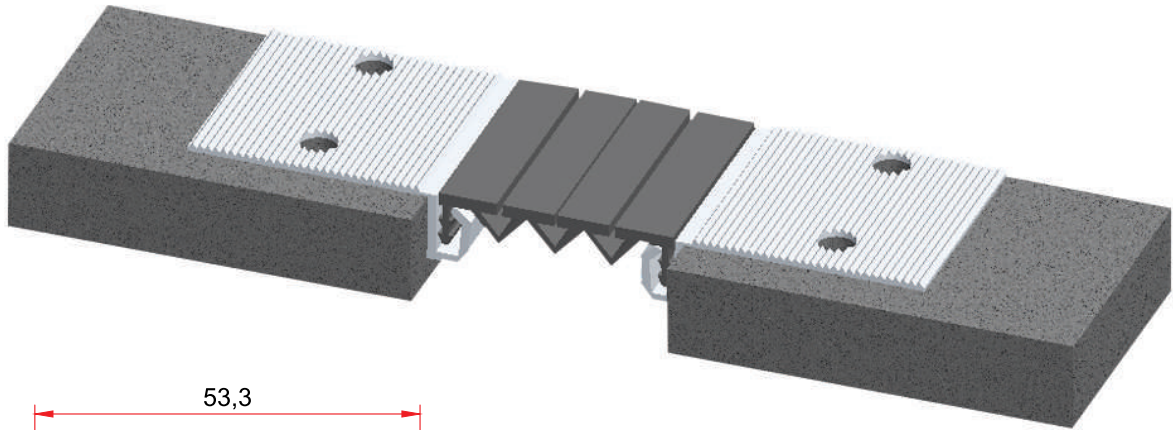
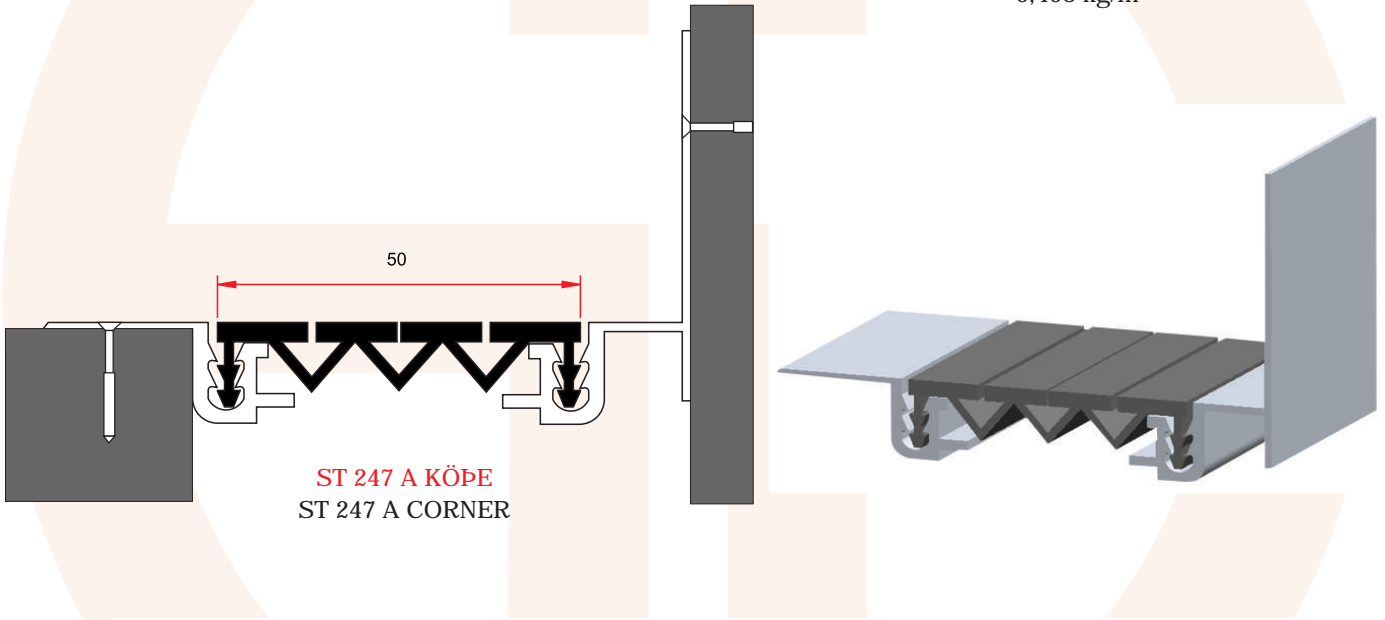
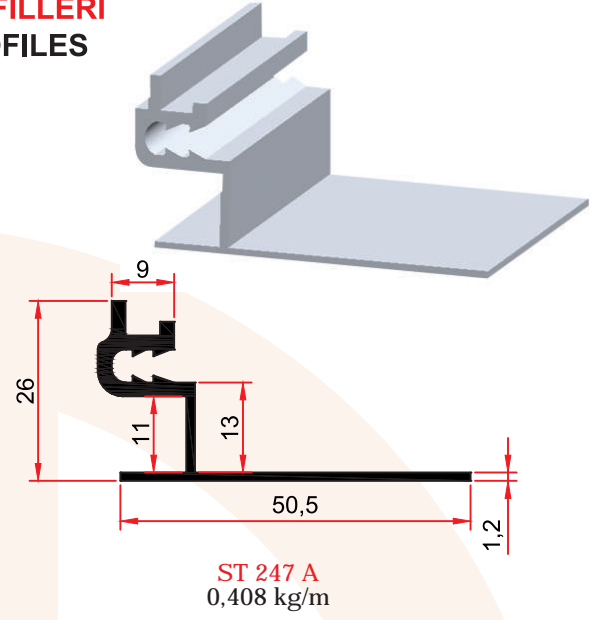
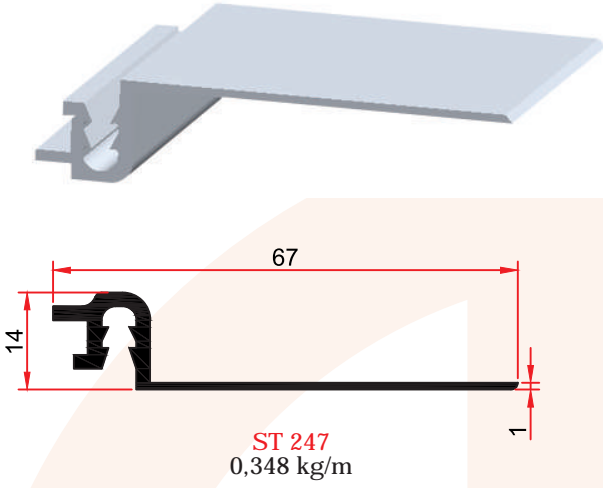

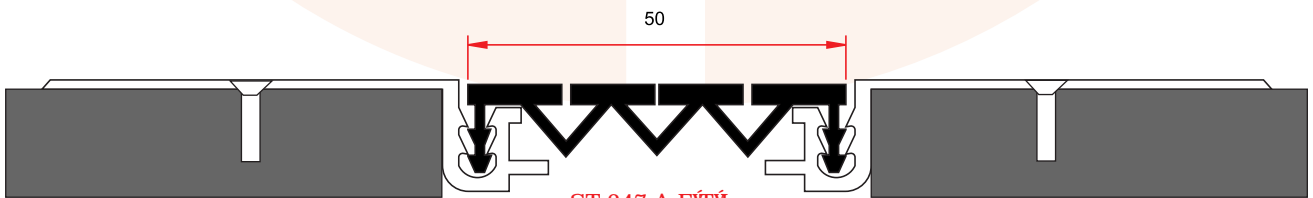
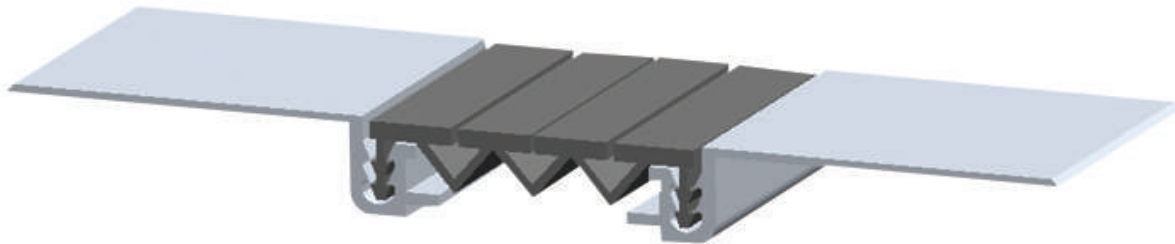
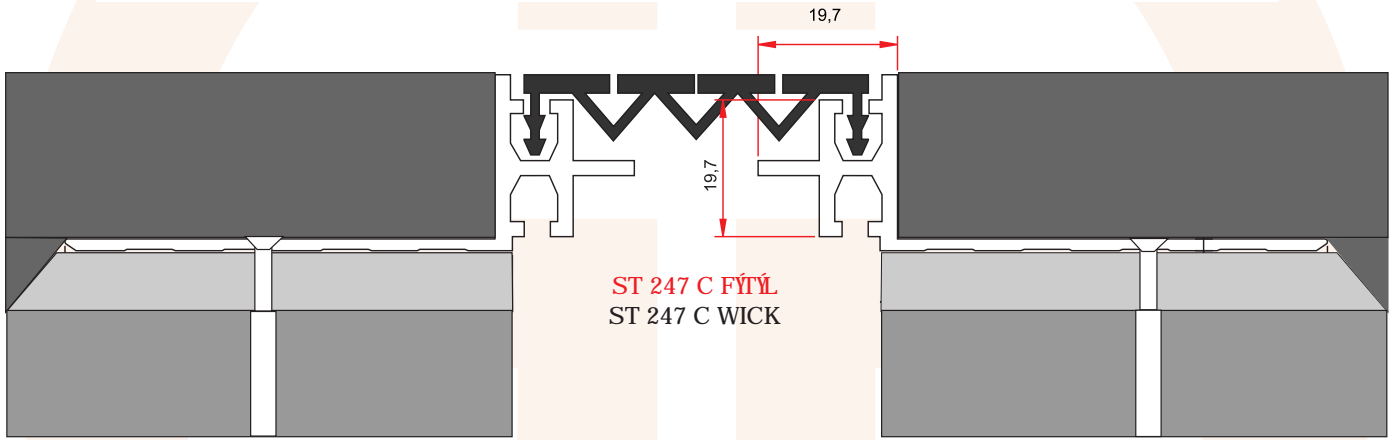
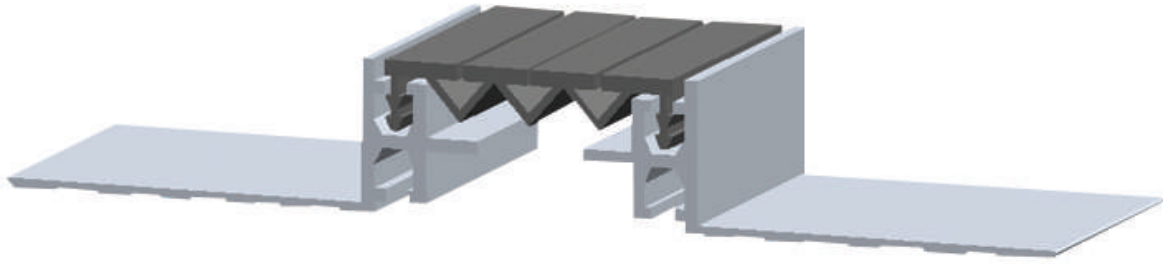
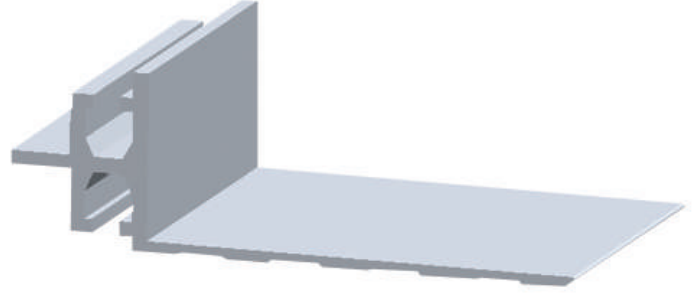
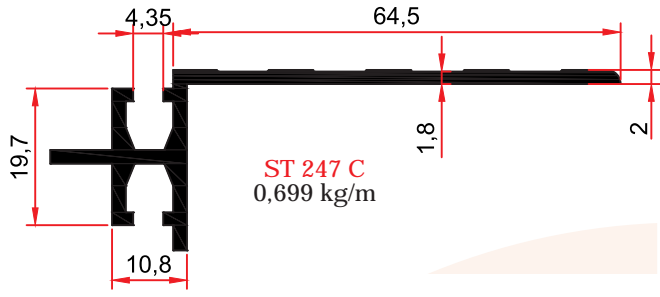

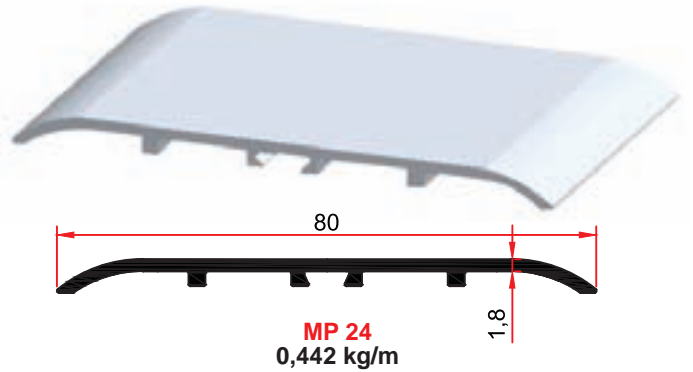
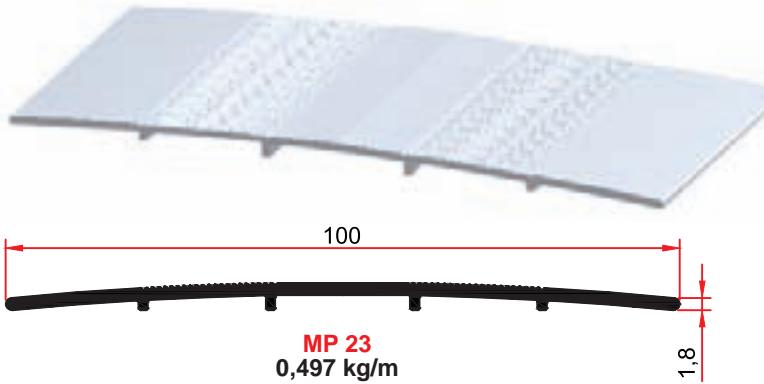
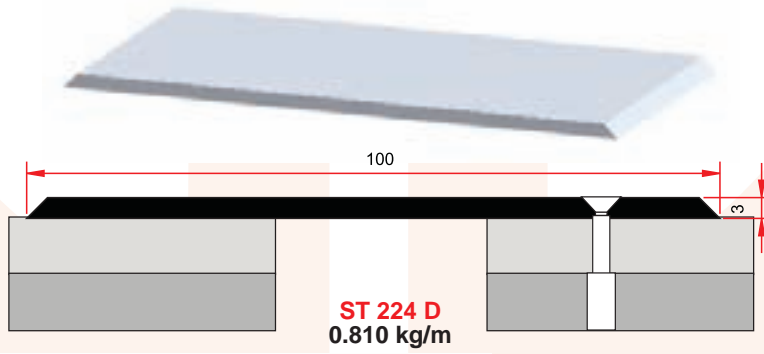
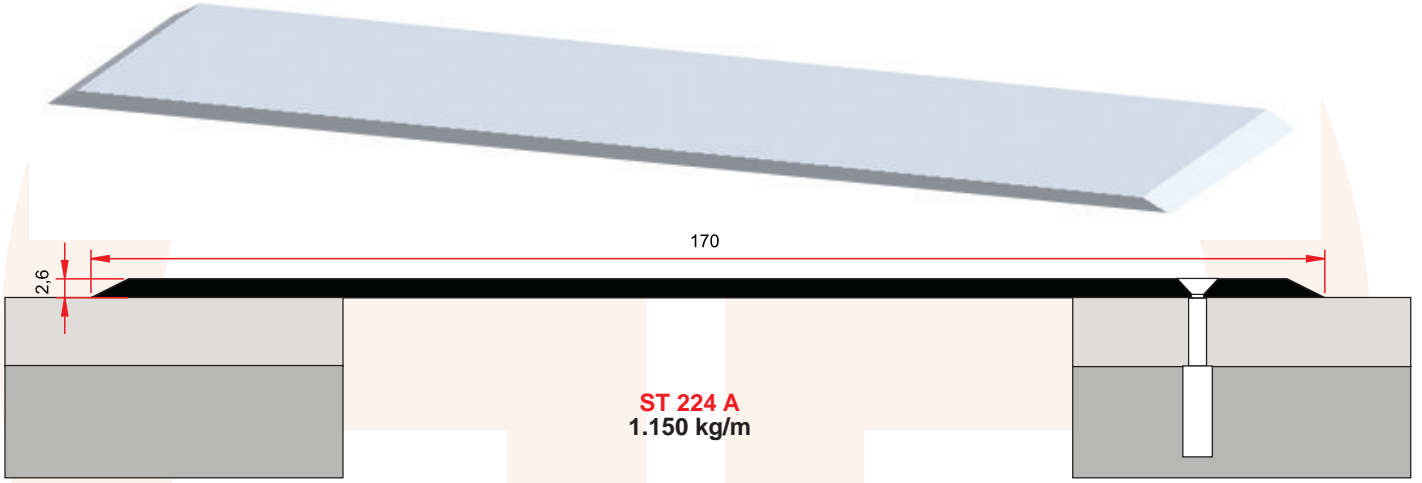
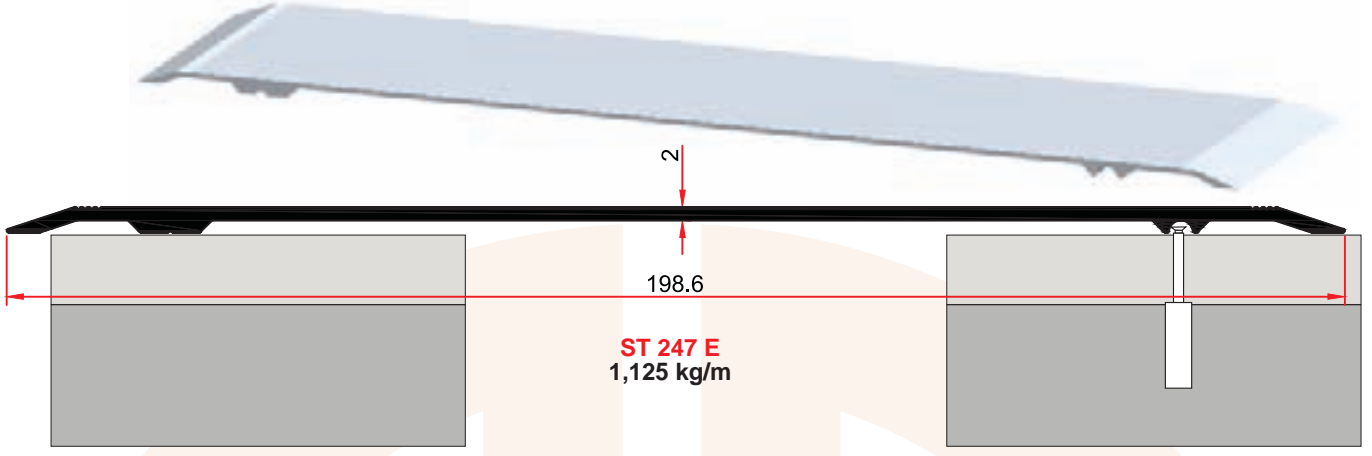

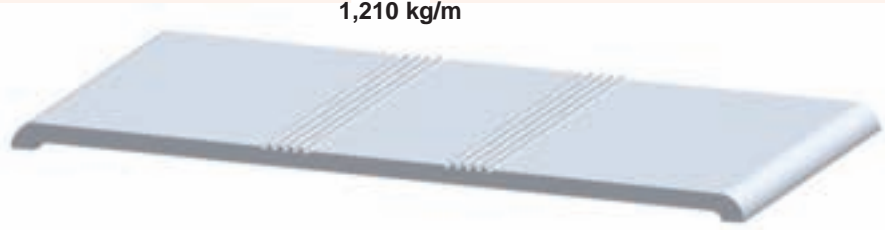
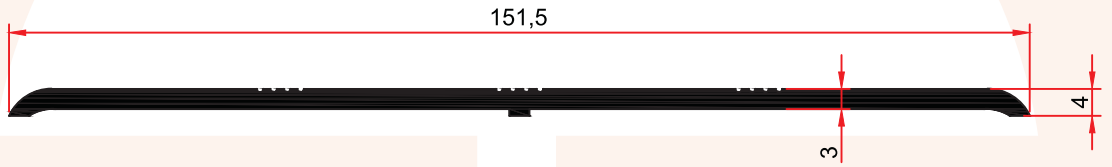
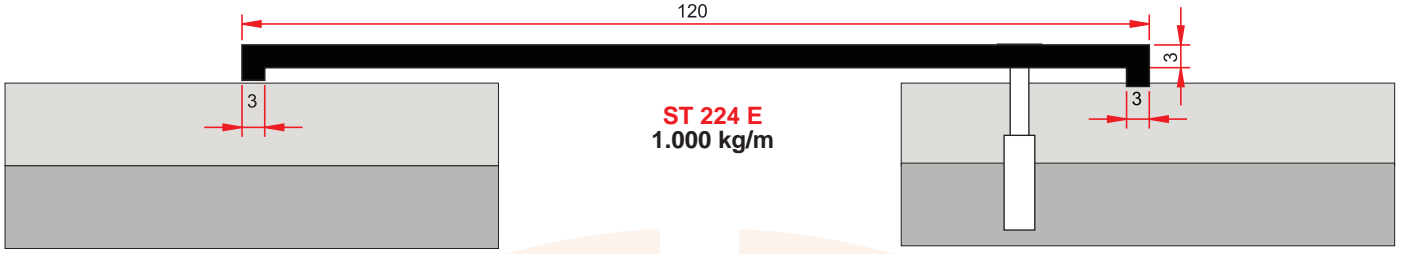

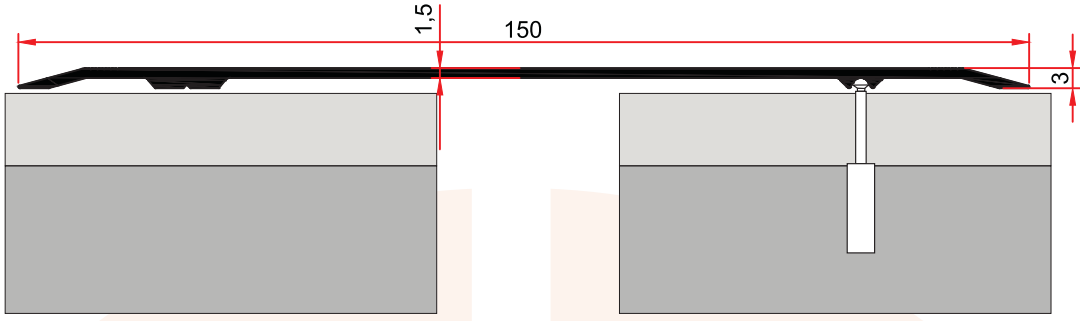

**ST 247 F**  
0,650 kg/m



**ST 247 D**  
0,500 kg/m

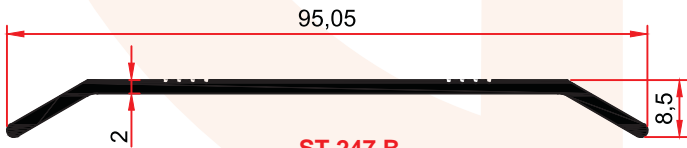

**ST 247 B**  
0,524 kg/m

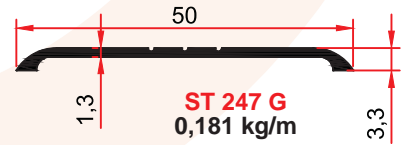

**ST 247 G**  
0,181 kg/m

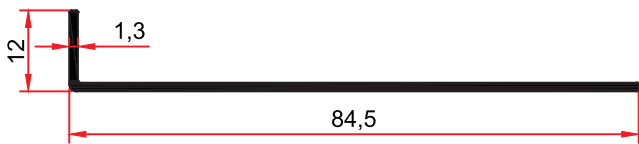

**SM 1064 D**  
0,335 kg/m



## HALI VE LAMİNA PARKE PROFİLLERİ CARPET & LAMINATED PARQUET PROFILES

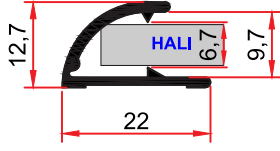

**ST 203**  
0,165 kg/m

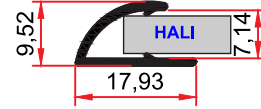

**ST 203 A**  
0,112 kg/m

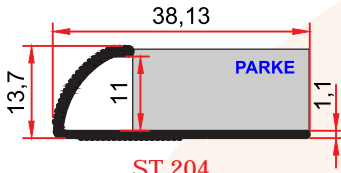

**ST 204**  
0,192 kg/m

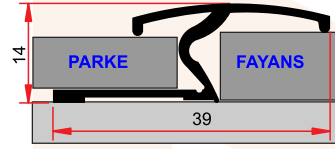

**ST 205**  
0,270 kg/m

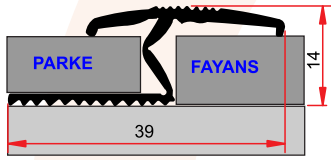

**ST 206**  
0,240 kg/m

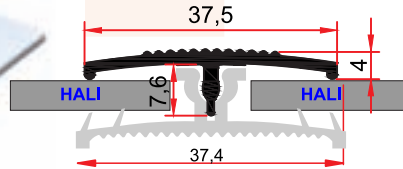

**ST 212**  
0,205 kg/m

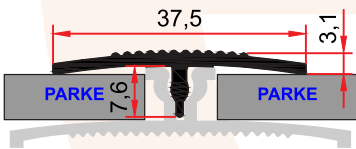

**ST 212 A**  
0,178 kg/m

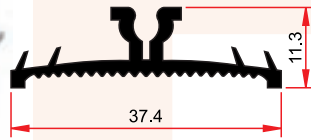

**ST 213 (Delikli)**  
0,350 kg/m  
Halı Dilatasyon Profili  
ST 213 DILATATION PROFILE

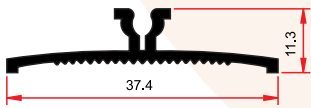

**ST 213**  
0,350 kg/m  
Parke Dilatasyon Profili

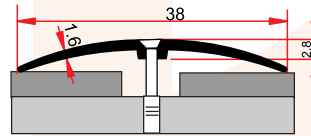

**ST 216**  
0,290 kg/m

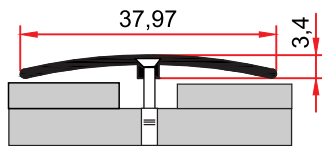

**ST 216 A**  
0,152 kg/m

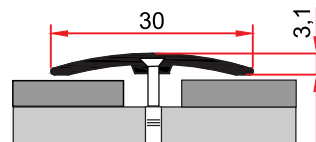

**ST 216 B**  
0,138 kg/m



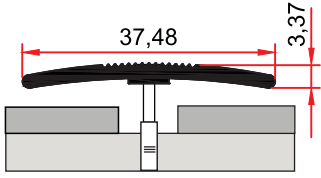

**ST 217**  
0,213 kg/m

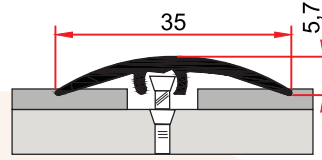
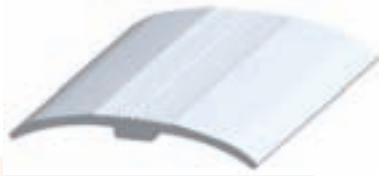

**ST 227**  
0,186 kg/m

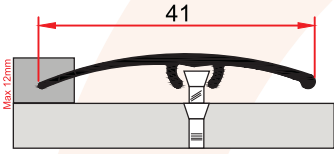

**ST 227 A**  
0,154 kg/m

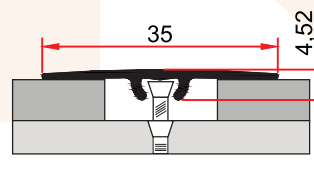

**ST 227 B**  
0,130 kg/m

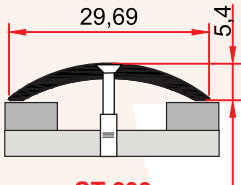

**ST 239**  
0,154 kg/m

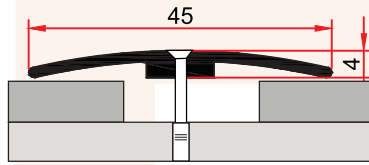

**ST 226 A**  
0,248 kg/m



**ST 217 C**  
0,160 kg/m

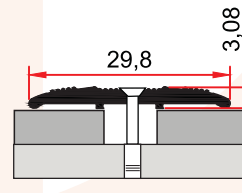

**ST 243 A**  
0,155 kg/m

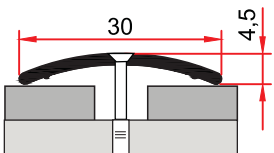

**ST 239 A**  
0,132 kg/m

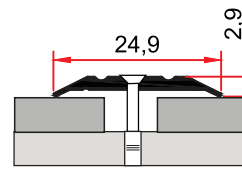

**ST 243**  
0,097 kg/m



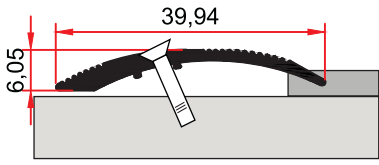

**ST 230 A**  
0,213 kg/m

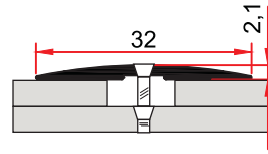

**MP 33**  
0,124 kg/m

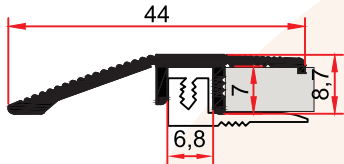

**ST 230**  
0,248 kg/m

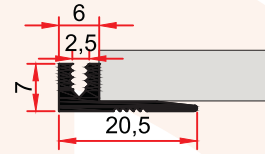

**ST 231**  
0,130 kg/m

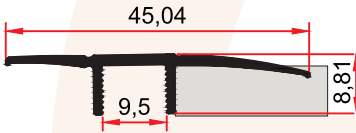
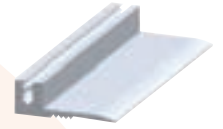

**MP 44**  
0,199 kg/m

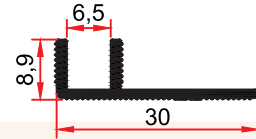
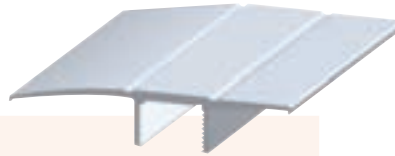

**MP 45**  
0,172 kg/m

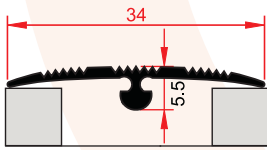

**ST 212 B**  
0,164 kg/m

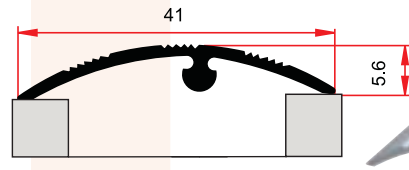

**ST 212 C**  
0,165 kg/m

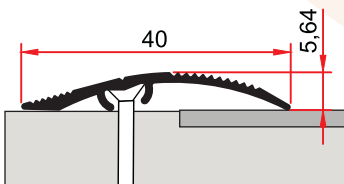

**ST 230 C**  
0,189 kg/m

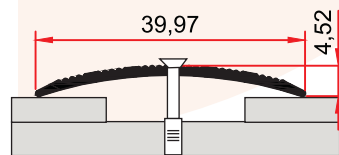

**ST 217 A**  
0,138 kg/m



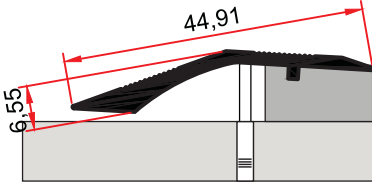

**ST 230 B**  
0,234 kg/m

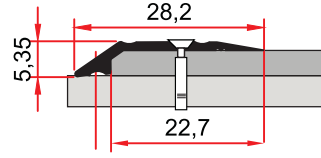

**ST 242**  
0,113 kg/m

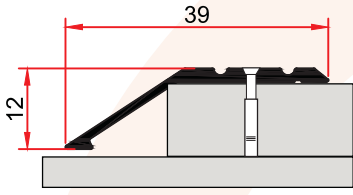
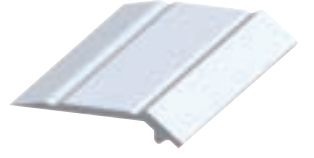

**MP 29**  
0,169 kg/m

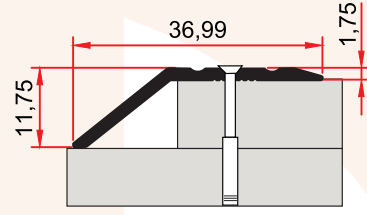

**ST 241 C**  
0,171 kg/m

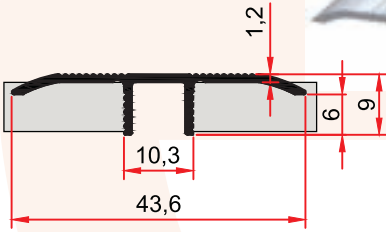
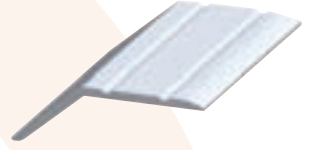

**ST 212 E**  
0,180 kg/m

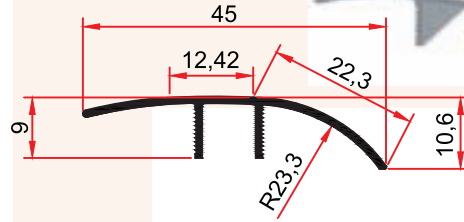

**ST 212 F**  
0,168 kg/m

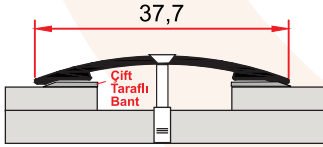
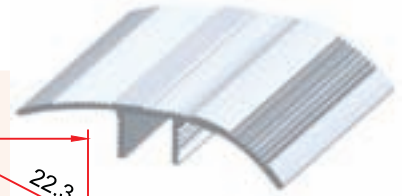

**ST 239 D**  
0,130 kg/m

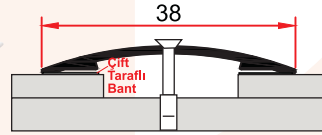
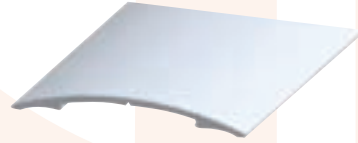

**ST 239 C**  
0,132 kg/m

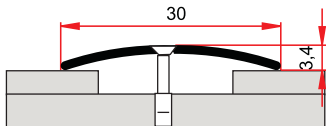
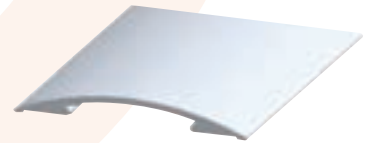

**ST 239 E**  
0,090 kg/m

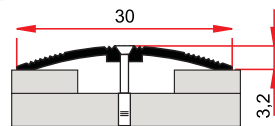
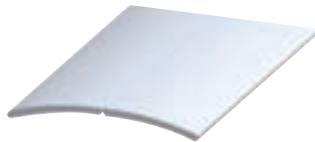

**ST 239 G**  
0,103 kg/m

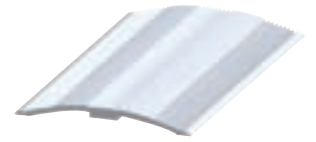

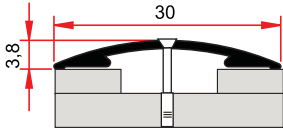

**ST 239 B**  
0,130 kg/m

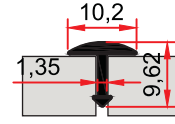
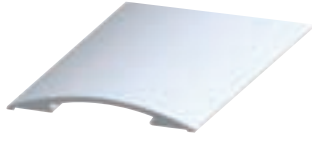

**MP 22**  
0,068 kg/m

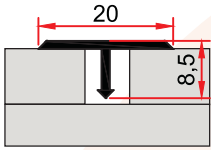

**SM 1022 A**  
0,084 kg/m

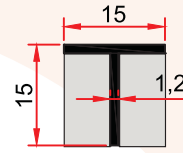
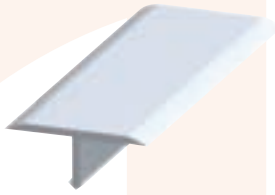

**SM 1022 B**  
0,097 kg/m

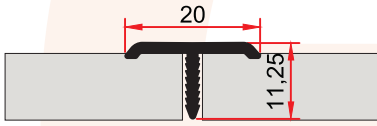
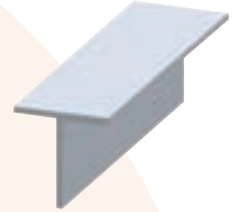

**SM 1022 D**  
0,122 kg/m

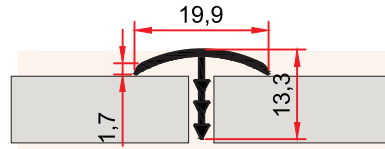
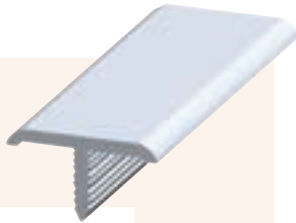

**SM 1023 A**  
0,092 kg/m

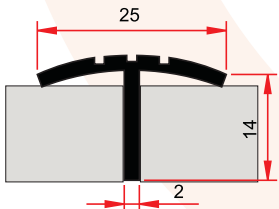

**SM 1023**  
0,188 kg/m

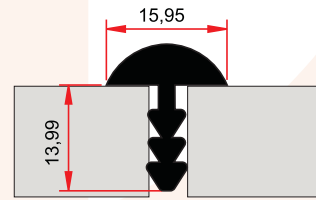
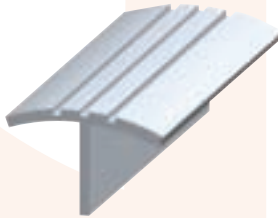

**SM 1023 B**  
0,180 kg/m

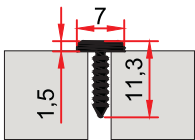

**SM 1023 C**  
0,070 kg/m

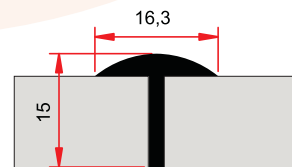

**SM 1093**  
0,145 kg/m

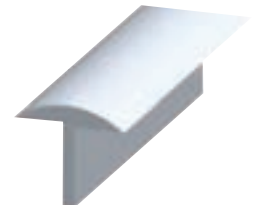

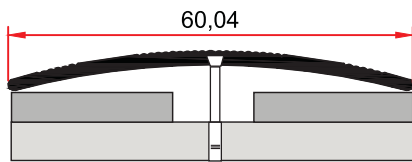
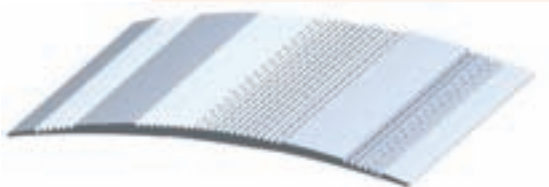
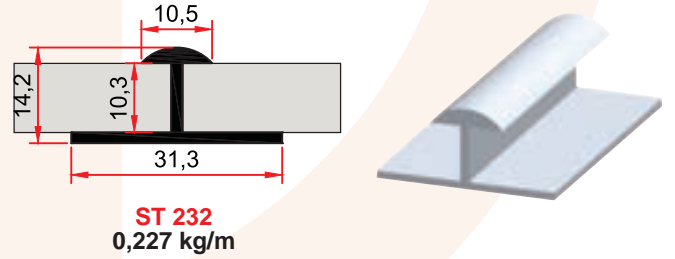
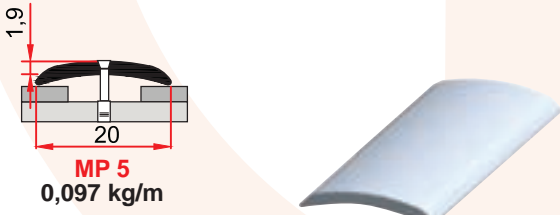
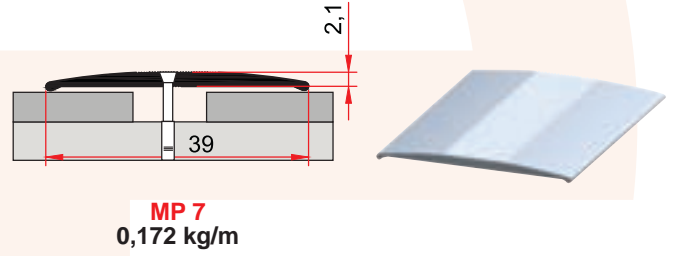
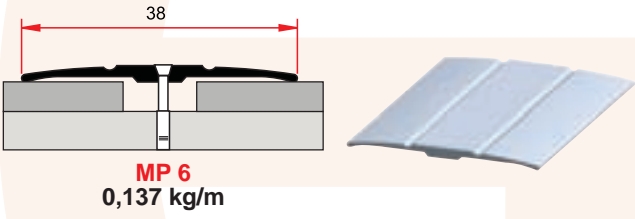
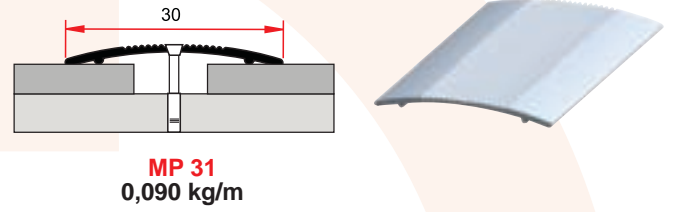
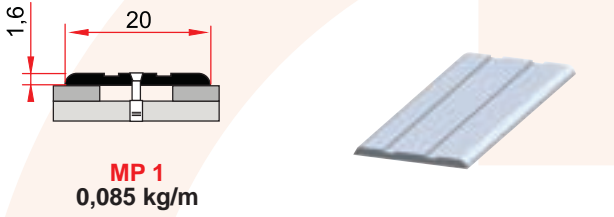
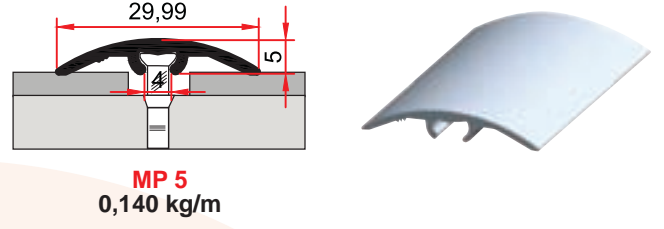
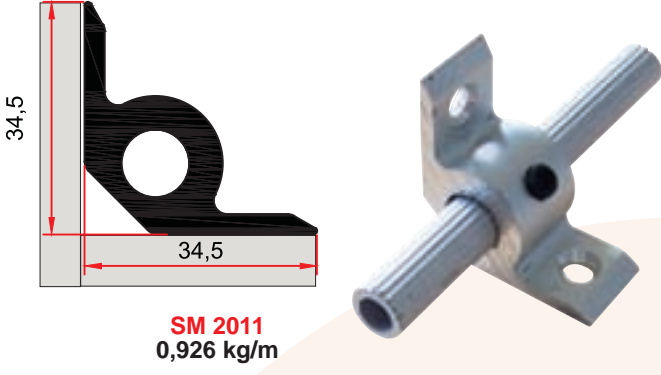

**MP 27**  
0,297 kg/m

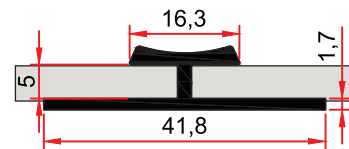
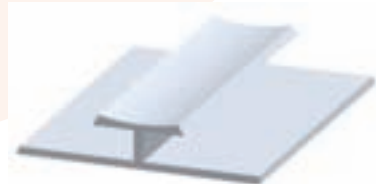

**ST 232 A**  
0,308 kg/m

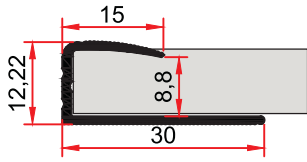

**ST 214**  
0,168 kg/m

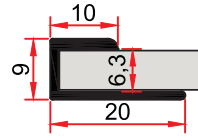

**ST 215**  
0,124 kg/m

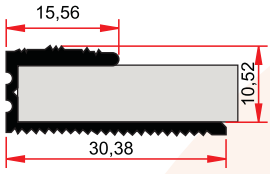
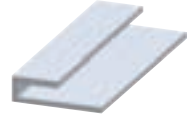

**ST 225**  
0,195 kg/m

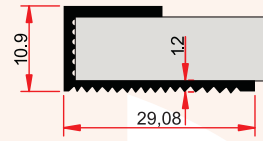
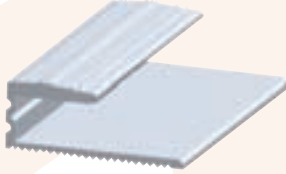

**ST 225 A**  
0,144 kg/m

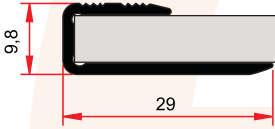
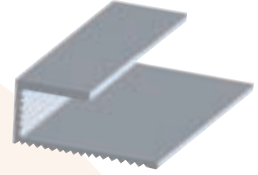

**ST 225 B**  
0,165 kg/m

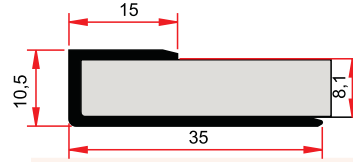
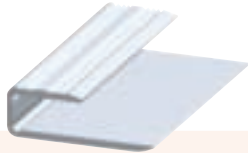

**ST 228**  
0,135 kg/m

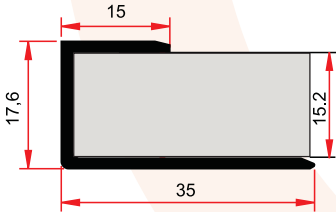

**ST 228 A**  
0,215 kg/m

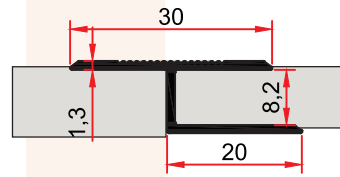

**ST 245**  
0,186 kg/m

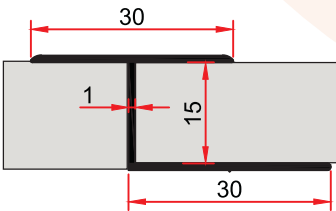
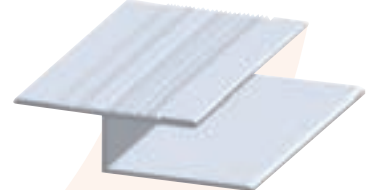

**ST 245 A**  
0,201 kg/m

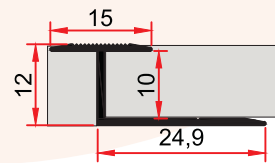
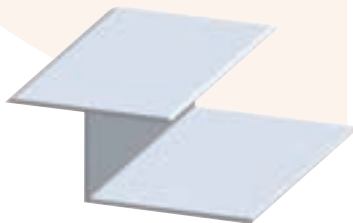

**MP 30**  
0,125 kg/m

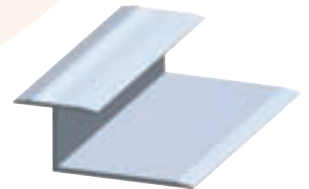

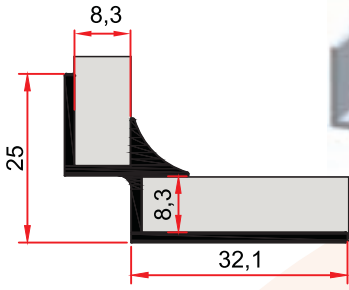

**ST 229 A**  
0,340 kg/m

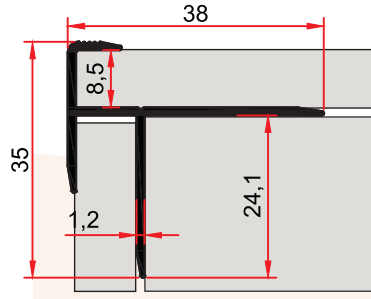

**ST 229**  
0,275 kg/m

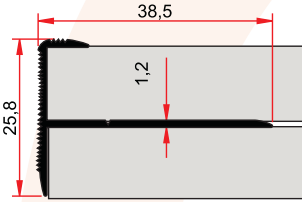

**ST 246 A**  
0,210 kg/m

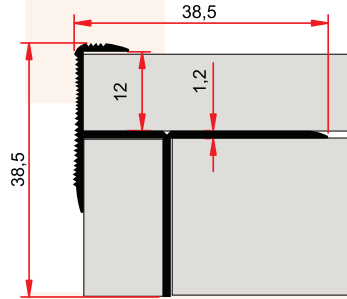

**ST 246 B**  
0,290 kg/m

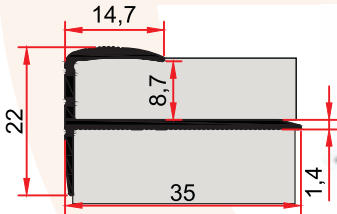

**ST 246 C**  
0,227 kg/m

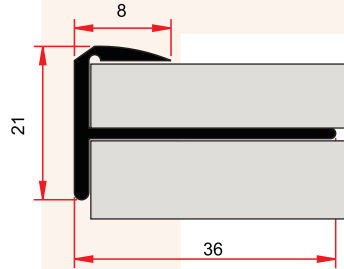

**ST 246**  
0,250 kg/m

**ST**

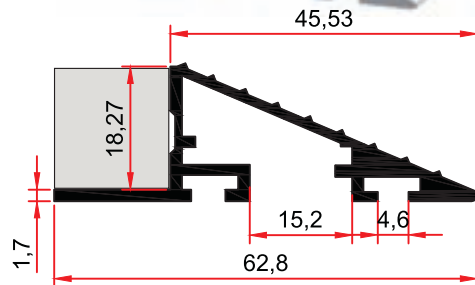
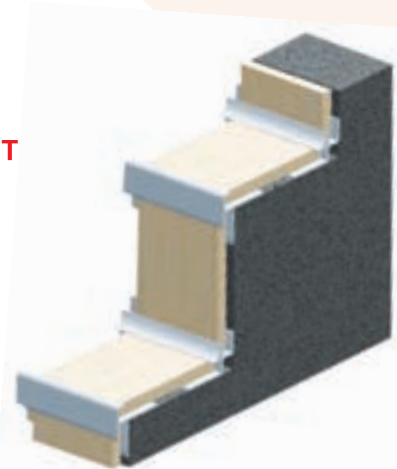

**ST 230 R**  
0,552 kg/m

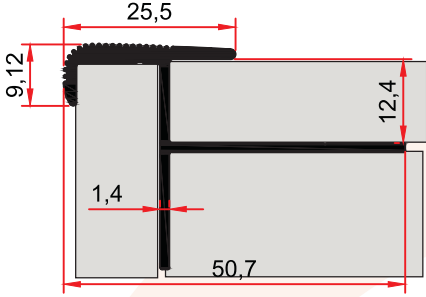
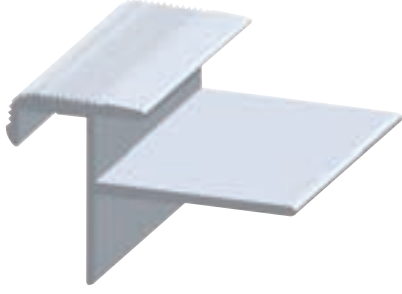

**ST 229 B**  
0,419 kg/m

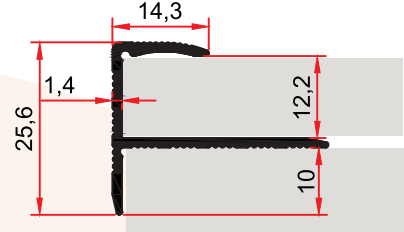
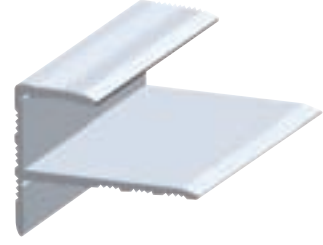

**ST 246 D**  
0,290 kg/m

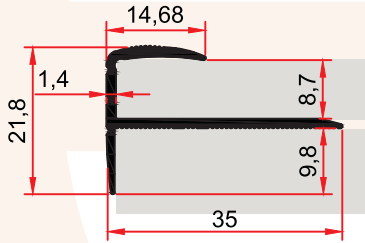

**ST 246 E**  
0,227 kg/m

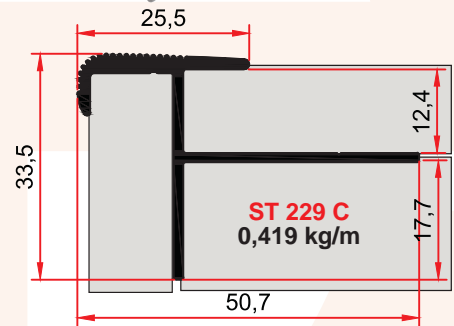
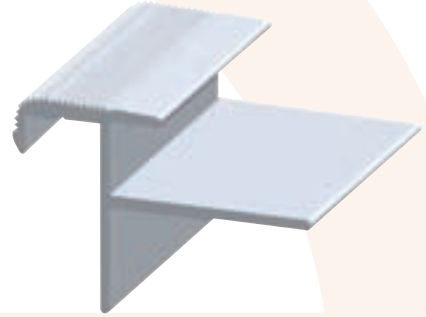

**ST 229 C**  
0,419 kg/m

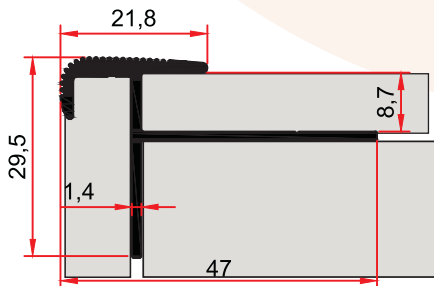
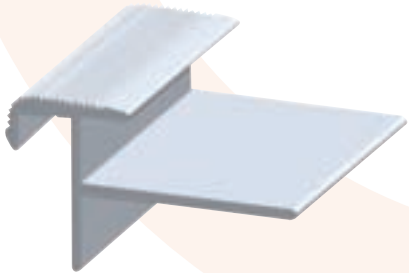

**ST 229 D**  
0,381 kg/m

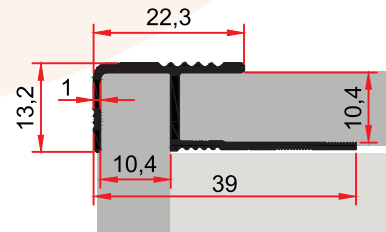
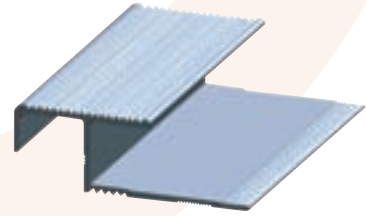

**MP 20**  
0,207 kg/m

## FAYANS ÇİTALARI - BASAMAK BURUNLUKLARI CERAMIC COVER & STEPNOSE PROFILES

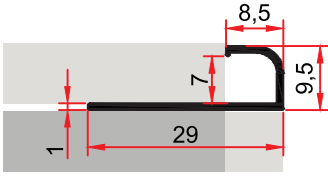

**ST 248**  
0,119 kg/m  
8 lik Fayans Çıtası  
8 MM CERAMIC COVER PROFILE

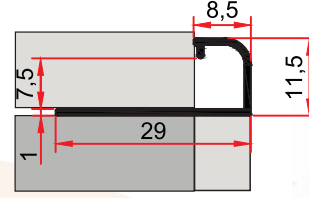

**ST 248 A**  
0,128 kg/m  
10 luk Fayans Çıtası  
10 MM CERAMIC COVER PROFILE

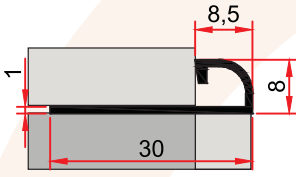

**ST 249**  
0,130 kg/m  
6'lik Fayans Çıtası  
6 MM CERAMIC COVER PROFILE

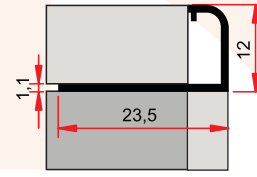

**ST 250 A**  
0,115 kg/m  
12 lik Fayans Çıtası  
12 MM CERAMIC COVER PROFILE

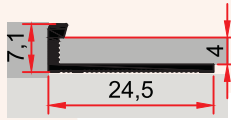

**ST 250 C**  
0,097 kg/m  
6 lik Basamak Burunluđu  
6 MM STEPNOSE PROFILE

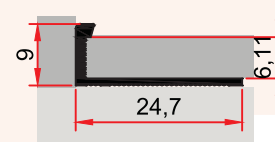

**ST 250 B**  
0,103 kg/m  
8 lik Basamak Burunluđu  
8 MM STEPNOSE PROFILE

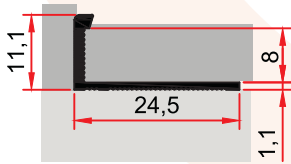

**ST 250 D**  
0,111 kg/m  
10 luk Basamak Burunluđu  
10 MM STEPNOSE PROFILE

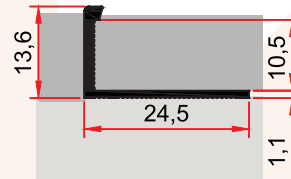

**ST 250 E**  
0,122 kg/m  
12 lik Basamak Burunluđu  
12 MM STEPNOSE PROFILE

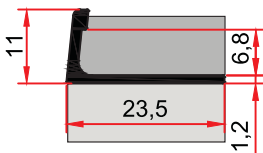

**ST 250**  
0,124 kg/m  
Basamak Burunluđu  
STEPNOSE PROFILE

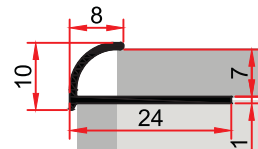

**ST 248 B**  
0,100 kg/m  
8 lik Fayans Çıtası  
8 MM CERAMIC COVER PROFILE



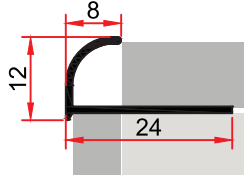

**ST 248 C**  
0,105 kg/m  
**10 luk Fayans Çıtası**  
10 MM CERAMIC COVER PROFILE

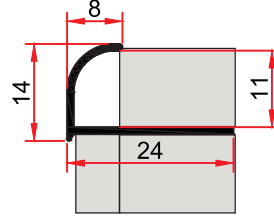

**ST 248 D**  
0,111 kg/m  
**12 lik Fayans Çıtası**  
12 MM CERAMIC COVER PROFILE

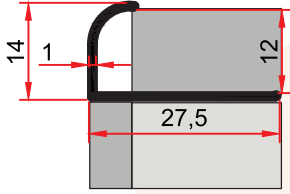

**MP 25**  
0,119 kg/m

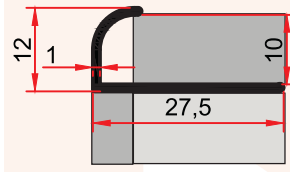

**MP 26**  
0,114 kg/m

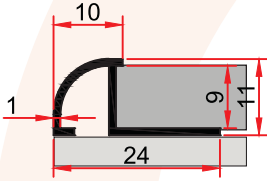

**ST 248 E**  
0,119 kg/m

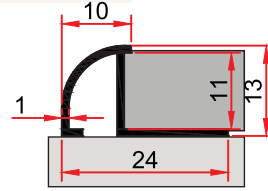

**ST 248 F**  
0,130 kg/m

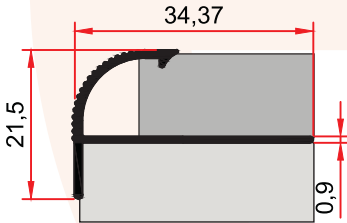

**ST 255**  
0,184 kg/m  
**Basamak Burunluđu**  
STEPNOSE PROFILE

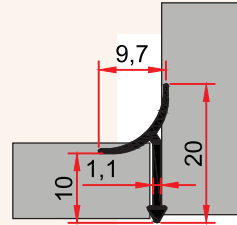
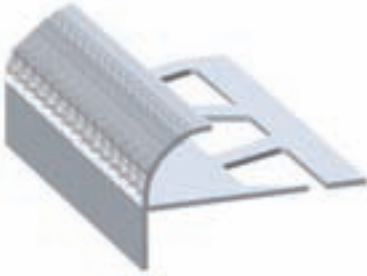

**MP 28**  
0,079 kg/m

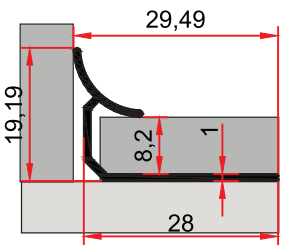

**MP 255 C**  
0,142 kg/m  
**Fayans İ Köşe 8 Luk**  
8 MM CERAMIC COVER PROFILE INNER

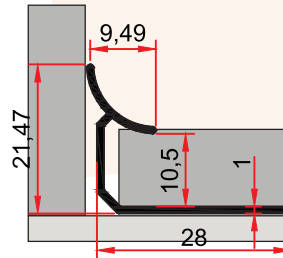

**MP 255 D**  
0,149 kg/m  
**Fayans İ Köşe 10 Luk**  
10 MM CERAMIC COVER PROFILE INNER

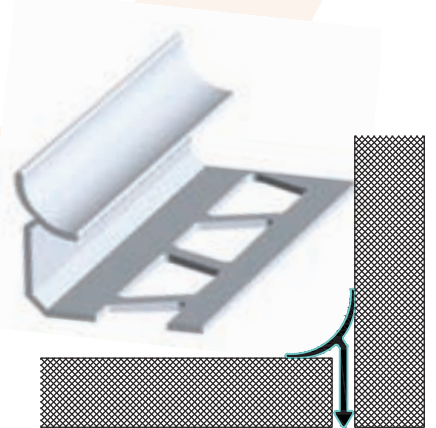

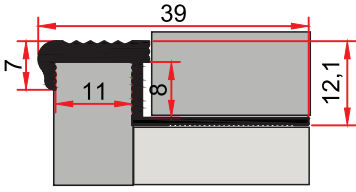

**ST 253 D**  
0,173 kg/m  
Basamak Burunluđu  
STEPNOSE PROFILE

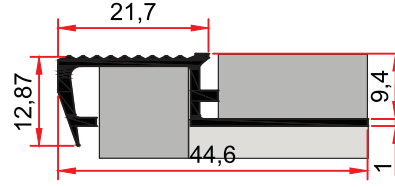

**ST 253**  
0,257 kg/m  
Basamak Burunluđu  
STEPNOSE PROFILE

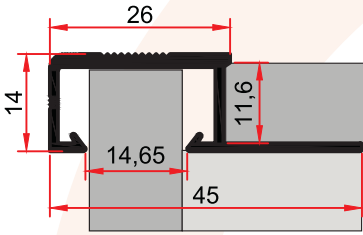

**ST 253 A**  
0,289 kg/m  
Basamak Burunluđu  
STEPNOSE PROFILE

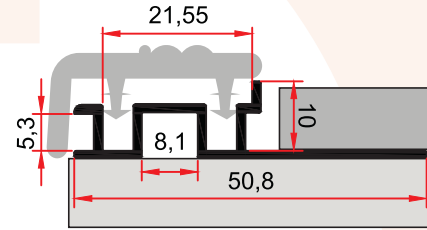
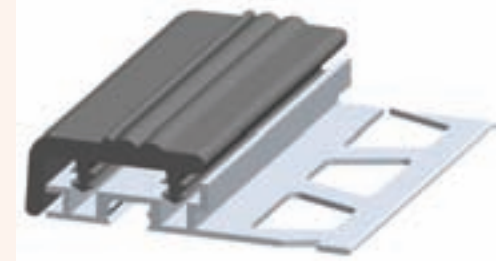
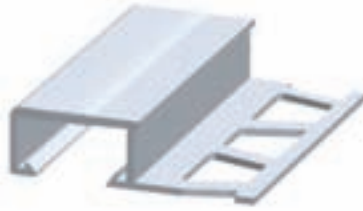

**ST 253 B**  
0,259 kg/m  
10 mm. Fitilli Basamak Burunluđu  
STEPNOSE PROFILE WITH WICK

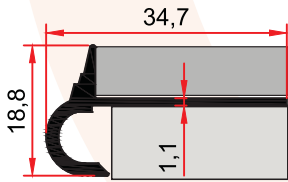

**ST 253 C**  
0,216 kg/m  
Süslü Basamak Burunluđu  
STEPNOSE PROFILE

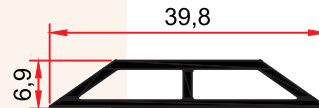
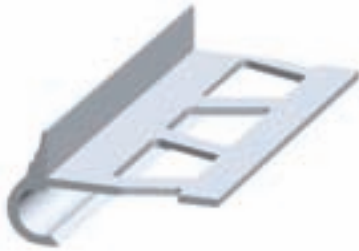

**ST 252 A**  
0,266 kg/m  
Anot Çıtası  
ANOD LATH

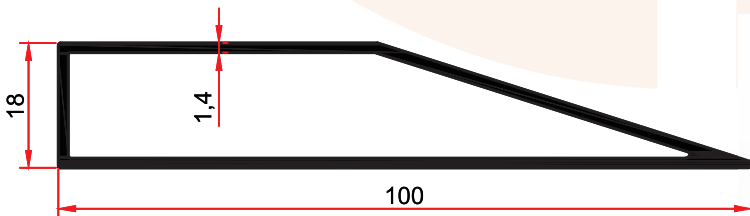

**ST 252**  
0,813 kg/m  
Alçı Sıva Mastarı  
GYPSUM PLASTER GAUGE



## KÖŞEBENTLER CORNER PROFILES

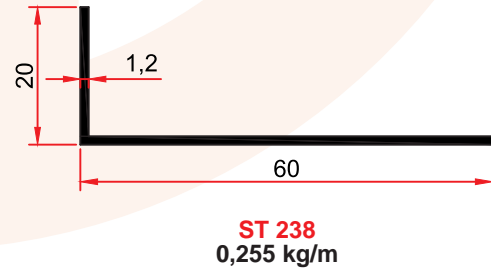
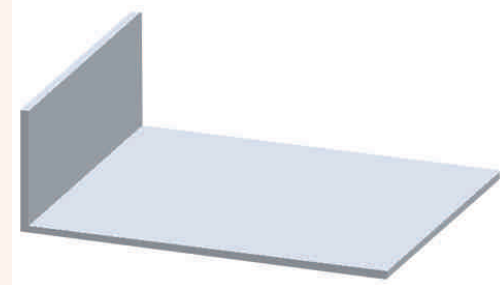
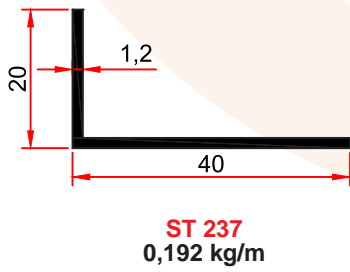
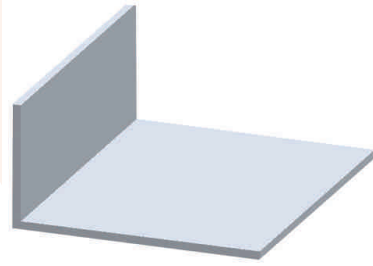
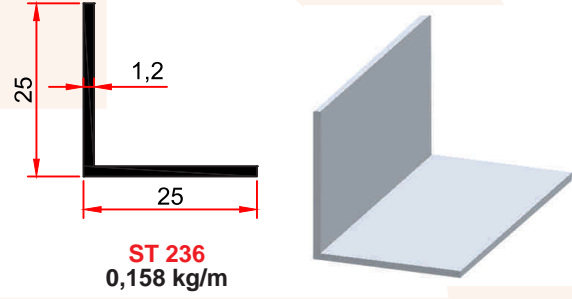
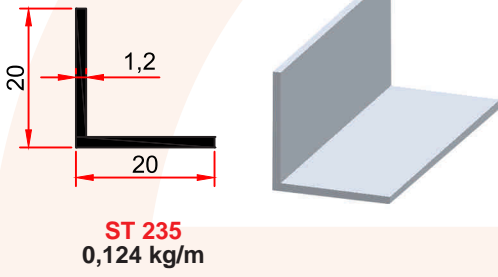
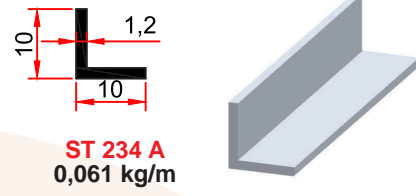
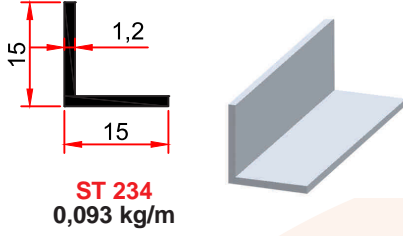



**İKİTELLİ MERKEZ :**

İkitelli O.S.B. Mahallesi Enkoop 2. Sk. No:6  
Başakşehir - İSTANBUL / TÜRKİYE  
Tel : +90.212 486 40 30 (pbx)  
Fax : +90.212 549 44 39

**HÜRRİYET ŞUBE :**

Hürriyet Mh. Dr. Cemil Bengü Cd.  
No: 19 Çağlayan - İSTANBUL / TÜRKİYE  
Tel : +90.212 224 20 13 - 224 20 04  
Fax : +90.212 224 20 05 - 225 64 95

**DUDULLU ŞUBE :**

Yeni Dudullu Nato Yolu Cad. Şengöz  
Sokak No: 8 Ümraniye - İSTANBUL / TÜRKİYE  
Tel : +90.216 415 34 34 Fax : +90.216 313 03 07  
Gsm: +90.533 963 90 15



[www.utkan-star.com](http://www.utkan-star.com) / [info@utkan-star.com](mailto:info@utkan-star.com) / [export@utkan-star.com](mailto:export@utkan-star.com)